

# ACRYLATE ESTERS

A SUMMARY OF SAFETY AND HANDLING

3RD EDITION



*Compiled by*  
ATOFINA Chemicals, Inc.  
BASF Corporation  
Celanese, Ltd.  
The Dow Chemical Company  
ROHM AND HAAS COMPANY

2002

## TABLE OF CONTENTS

---

<b>1</b>	<b>INTRODUCTION.....</b>	<b>1</b>
<b>2</b>	<b>NAMES AND GENERAL INFORMATION.....</b>	<b>2</b>
2.1	ODOR.....	2
2.2	REACTIVITY.....	2
<b>3</b>	<b>PROPERTIES AND CHARACTERISTICS OF ACRYLATES.....</b>	<b>3</b>
<b>4</b>	<b>SAFETY AND HANDLING MANAGEMENT TRAINING.....</b>	<b>5</b>
4.1	GENERAL CONSIDERATIONS.....	5
4.2	SAFETY, HEALTH AND ENVIRONMENTAL REVIEWS.....	5
4.3	WRITTEN OPERATING PROCEDURES.....	5
4.4	DOCUMENTED TRAINING PROGRAM.....	5
4.5	WRITTEN EMERGENCY RESPONSE PLANS.....	5
<b>5</b>	<b>HEALTH AND SAFETY INFORMATION.....</b>	<b>6</b>
5.1	TOXICOLOGY.....	6
5.1.1	<i>General.....</i>	6
5.1.2	<i>Acute Exposure.....</i>	6
5.1.3	<i>Chronic Exposure.....</i>	6
5.2	INDUSTRIAL HYGIENE.....	6
5.2.1	<i>General.....</i>	6
5.2.2	<i>Personal Hygiene.....</i>	7
5.3	MEDICAL MANAGEMENT.....	7
5.4	FIRST AID.....	7
5.4.1	<i>General.....</i>	7
5.4.2	<i>Contact with Eyes.....</i>	8
5.4.3	<i>Contact with Skin.....</i>	8
5.4.4	<i>Inhalation.....</i>	8
5.4.4.1	<i>Suggestions to Physicians.....</i>	8
5.4.5	<i>Ingestion.....</i>	8
5.5	PERSONAL PROTECTIVE EQUIPMENT.....	8
5.5.1	<i>General.....</i>	8
5.5.2	<i>Eye Protection.....</i>	9
5.5.3	<i>Skin Protection.....</i>	9
5.5.4	<i>Respiratory Protection.....</i>	9
5.5.5	<i>Head Protection.....</i>	9
<b>6</b>	<b>INSTABILITY AND REACTIVITY HAZARDS.....</b>	<b>9</b>
6.1	POLYMERIZATION.....	9
6.2	FLAMMABILITY.....	10
<b>7</b>	<b>BULK STORAGE FACILITIES AND ACCESSORIES.....</b>	<b>11</b>
7.1	GENERAL CONSIDERATIONS.....	11
7.1.1	<i>Odor Control.....</i>	12
7.2	DESIGN CONSIDERATIONS.....	12
7.2.1	<i>Temperature Control of Bulk Storage Tanks and Accessories.....</i>	13
7.2.2	<i>Pumps and Protection of Pumps from Overheating.....</i>	13
7.2.3	<i>Detecting Unsafe Conditions Inside Bulk Storage Vessels.....</i>	13
7.2.4	<i>Avoiding Polymer Formation in Vent Nozzles and Lines.....</i>	14
7.2.5	<i>Heating of Liquid Acrylate Monomer.....</i>	14
7.2.6	<i>Indoor Acrylates Storage Facilities.....</i>	14
7.2.7	<i>Engineering Features for Environmental Protection.....</i>	14

7.2.8	<i>Engineering Considerations for Fire Control</i> .....	15
7.2.8.1	Mixed Gas Systems.....	15
7.2.9	<i>Materials for Construction and Sealing in Acrylate Service</i> .....	16
7.2.10	<i>Venting of Bulk Storage Tanks</i> .....	16
7.2.11	<i>Emergency Venting of Bulk Storage Tanks</i> .....	16
7.2.12	<i>Other Bulk Storage Tank Accessories</i> .....	16
7.2.13	<i>Summary of Special Recommended Design Features for Bulk Acrylates Storage Facilities and Accessories</i> .....	17
<b>8</b>	<b>EQUIPMENT PREPARATION AND CLEANING</b> .....	<b>20</b>
8.1	GENERAL CONSIDERATIONS.....	20
8.2	PREPARATION OF THE TANK AND EQUIPMENT.....	20
8.3	COMMISSIONING ACRYLATES BULK STORAGE FACILITIES.....	20
8.4	CLEANING ACRYLATE BULK STORAGE FACILITIES FOR DECOMMISSIONING.....	20
<b>9</b>	<b>SAFE TRANSPORT OF ACRYLATES</b> .....	<b>21</b>
9.1	PERSONAL PROTECTIVE EQUIPMENT FOR UNLOADING AND HANDLING.....	21
9.2	GENERAL CONSIDERATIONS.....	21
9.3	TRANSPORTATION INCIDENTS – IMMEDIATE ACTIONS.....	22
9.3.1	<i>Bulk Cargo Temperatures</i> .....	22
9.4	TRUCKS.....	22
9.4.1	<i>Carrier information</i> .....	22
9.4.2	<i>Unloading</i> .....	23
9.4.2.1	Unloading Trucks with Closed Loop System.....	23
9.4.2.2	Unloading Trucks With Pressure.....	24
9.5	RAIL CARS.....	25
9.5.1	<i>Carrier Information</i> .....	25
9.5.2	<i>Unloading</i> .....	25
9.5.2.1	Unloading Rail Cars with Closed Loop System.....	26
9.5.2.2	Unloading Rail Cars with Pressure.....	26
9.6	DRUMS AND INTERMEDIATE BULK CONTAINERS (TOTES).....	27
9.6.1	<i>Carrier Information</i> .....	27
9.6.2	<i>Storage of Drums and Intermediate Bulk Containers (Totes)</i> .....	27
9.6.3	<i>Handling Procedures</i> .....	28
9.6.3.1	Receipt of Drums and Intermediate Bulk Containers (Totes).....	28
9.6.3.2	Emptying Drums and Intermediate Bulk Containers (Totes).....	28
<b>10</b>	<b>ENVIRONMENTAL CONSIDERATIONS FOR ACRYLATES</b> .....	<b>29</b>
10.1	ENVIRONMENTAL FATE.....	29
10.1.1	<i>Biodegradation</i> .....	29
10.1.2	<i>Volatilization / Soil Adsorption</i> .....	29
10.2	DISCHARGES.....	29
10.2.1	<i>General Information</i> .....	29
10.2.2	<i>Discharges to Navigable Waters</i> .....	29
10.2.3	<i>Discharges to Municipal Sewers</i> .....	29
10.2.4	<i>Emissions to Air</i> .....	30
10.2.4.1	Removal of Acrylate Vapors from Contaminated Air.....	30
10.2.5	<i>Releases to Land</i> .....	30
10.3	SPILL AND LEAK CONTROL.....	31
10.3.1	<i>General Information</i> .....	31
10.3.2	<i>Small Spills (Up To 4 Liters)</i> .....	31
10.3.3	<i>Large Spills (Greater Than 4 Liters)</i> .....	31
10.4	DISPOSAL OF WASTES.....	31

<b>11</b>	<b>EMERGENCY RESPONSE.....</b>	<b>32</b>
11.1	DETECTION AND RESPONSE TO INCIPIENT POLYMERIZATION IN A STORAGE TANK.....	32
11.1.1	<i>Initiation Scenarios.....</i>	32
11.1.2	<i>Polymerization Detection.....</i>	32
11.1.3	<i>Restabilization (Shortstopping – An Optional Safety Enhancement).....</i>	33
11.1.3.1	Restabilization (Shortstop) Inhibitor.....	33
11.1.3.2	Restabilization (Shortstop) Inhibitor Solvent.....	33
11.1.3.3	Activation Criteria for Restabilization (Shortstop) Systems.....	33
11.1.3.4	Mixing of Restabilization (Shortstop) Inhibitor.....	34
11.1.3.5	Examples of Restabilization (Shortstop) Systems.....	34
11.2	SPILLS.....	36
11.3	FIRES.....	36
11.3.1	<i>Procedures.....</i>	36
11.3.2	<i>Extinguishing Media.....</i>	36
11.3.3	<i>Fire Prevention Suggestions.....</i>	37
<b>12</b>	<b>ACKNOWLEDGMENTS.....</b>	<b>38</b>
<b>13</b>	<b>APPENDIX.....</b>	<b>38</b>
13.1	INCOMPATIBLE MATERIALS.....	38
<b>14</b>	<b>REFERENCES.....</b>	<b>39</b>

## LIST OF TABLES AND ILLUSTRATIONS

---

<b>TABLE 2-1:</b>	<b>NAMES AND GENERAL INFORMATION FOR ACRYLATES.....</b>	<b>2</b>
<b>TABLE 3-1:</b>	<b>PROPERTIES AND CHARACTERISTICS OF ACRYLATE ESTERS.....</b>	<b>3, 4</b>
<b>TABLE 7-1:</b>	<b>SUMMARY OF SPECIAL RECOMMENDED DESIGN FEATURES FOR BULK ACRYLATES STORAGE FACILITIES AND ACCESSORIES.....</b>	<b>17</b>
<b>TABLE 7-2:</b>	<b>KEY TO SYMBOLS IN FIGURES 7-1, 7-2, 11-1 AND 11-2.....</b>	<b>18</b>
<b>TABLE 9-1:</b>	<b>SUMMARY OF SHIPPING AND PLACARDING ACRYLATES.....</b>	<b>28</b>
<b>FIGURE 7-1:</b>	<b>EXAMPLE OF AN ACRYLATE MONOMER STORAGE FACILITY.....</b>	<b>19</b>
<b>FIGURE 7-2:</b>	<b>EXAMPLE OF AN ACRYLATE MONOMER PUMP LOOP.....</b>	<b>19</b>
<b>FIGURE 9-1:</b>	<b>ACRYLATES TANK TRUCKS.....</b>	<b>24</b>
<b>FIGURE 11-1:</b>	<b>ACRYLATES SHORTSTOP SYSTEM EXAMPLE I.....</b>	<b>35</b>
<b>FIGURE 11-2:</b>	<b>ACRYLATES SHORTSTOP SYSTEM EXAMPLE II.....</b>	<b>35</b>

The Intercompany Committee for the Safety and Handling of Acrylic Monomers, ICSHAM, consists of companies that are involved in manufacturing and/or marketing of acrylic acid and its basic esters (methyl, ethyl, butyl, and 2-ethylhexyl acrylates) in the United States of America. The group is committed to sharing information on the safe handling and storage of acrylic monomers among themselves, with their customers, carriers, and other handlers of acrylic monomers. The member companies are ATOFINA Chemicals, Inc., BASF Corporation, Celanese, Ltd, The Dow Chemical Company and ROHM AND HAAS COMPANY. The purpose of this brochure is to provide general information on the safe handling and storage of hydroquinone monomethyl ether (MEHQ) inhibited basic esters of acrylic acid, hereafter referred to as acrylates, acrylate esters, or acrylate monomers. The information in this brochure is based on research and experience of ICSHAM member companies in addition to that taken from accompanied references. It is suggested that this entire document along with your material safety data sheets (MSDSs) be read before using the information provided. In addition, you are strongly encouraged to call your acrylates supplier with any further questions you may have.

Acrylates will readily polymerize if not properly inhibited. Uncontrolled polymerization can be rapid and very violent, generating large amounts of heat, which increase the pressure. This increase in pressure can cause the ejection of hot vapor and polymer which may autoignite. Explosions have been caused by uncontrolled polymerization of acrylates.

There have been several serious accidents over the past 25 years, several involving explosions. Causes of polymerization are excessive or inadvertent heating, the deficiency of dissolved oxygen (oxygen is necessary to activate the storage inhibitor, MEHQ) and contamination with other chemicals.

This brochure is intended to provide essential information that personnel who work with acrylates may use to avoid dangerous conditions. Features which prevent unsafe conditions should be a key part of the design and operation of acrylates storage facilities. The fundamental elements of a well designed storage system are: temperature monitoring, use of oxygen-containing blanket gas (5 to 21 vol. percent), and dedicated piping and equipment to prevent contamination. A properly designed facility must be coupled with safe operating discipline. Even a well designed system may not prevent all incidents. Because of factors of human error and the type of management procedures used, additional protection may be desired. Restabilization or "shortstop" systems are a safety enhancement option which can sometimes be used to mitigate a runaway polymerization.

Comments and suggestions on improving this brochure are welcomed and can be forwarded to your acrylates supplier.

ICSHAM AND ITS MEMBER COMPANIES BELIEVE THE INFORMATION CONTAINED IN THIS DOCUMENT IS FACTUAL. HOWEVER, NO WARRANTY OR REPRESENTATION (INCLUDING ANY WARRANTY OF MERCHANTABILITY, FITNESS FOR A PARTICULAR USE OR NON-INFRINGEMENT OF THIRD PARTY PATENTS) EXPRESSED OR IMPLIED, IS MADE WITH RESPECT TO ANY OR ALL OF THE CONTENT HEREIN. ICSHAM AND ITS MEMBER COMPANIES ASSUME NO LEGAL RESPONSIBILITY FOR YOUR USE OF THIS INFORMATION AND URGE YOU TO MAKE ALL APPROPRIATE INVESTIGATIONS AND TESTS TO DETERMINE THE APPLICABILITY OF THIS INFORMATION TO YOUR SPECIFIC SITUATION.

**Table 2-1: Names and General Information for Acrylates**

Chemical Name	Methyl Acrylate	Ethyl Acrylate	n-Butyl Acrylate	2-Ethylhexyl Acrylate
Common Name	Methyl Acrylate	Ethyl Acrylate	n-Butyl Acrylate	2-Ethylhexyl Acrylate
Synonyms	Methyl 2-Propenoate	Ethyl 2-Propenoate	n-Butyl 2-Propenoate	2-Ethylhexyl 2-Propenoate
	Acrylic Acid, Methyl Ester	Acrylic Acid, Ethyl Ester	Acrylic Acid, n-Butyl Ester	Acrylic Acid, 2-Ethylhexyl Ester
CA Registry Number	96-33-3	140-88-5	141-32-2	103-11-7
Chemical Formula	CH <sub>2</sub> =CHCOOCH <sub>3</sub>	CH <sub>2</sub> =CHCOOC <sub>2</sub> H <sub>5</sub>	CH <sub>2</sub> =CHCOOC <sub>4</sub> H <sub>9</sub>	CH <sub>2</sub> =CHCOOCH <sub>2</sub> CH- (C <sub>2</sub> H <sub>5</sub> )C <sub>4</sub> H <sub>9</sub>
Stoichiometric Formula	C <sub>4</sub> H <sub>6</sub> O <sub>2</sub>	C <sub>5</sub> H <sub>8</sub> O <sub>2</sub>	C <sub>7</sub> H <sub>12</sub> O <sub>2</sub>	C <sub>11</sub> H <sub>20</sub> O <sub>2</sub>
United Nations Number	1919	1917	2348	NA1993

## 2.1 ODOR

The acrylates have very low odor thresholds and may cause discomfort even at low concentrations. Odor threshold concentration ranges for the acrylates covered in this guide are<sup>1</sup>:

Methyl Acrylate	3-20 ppb
Ethyl Acrylate	0.2-1.3 ppb
n-Butyl Acrylate	0.9-100 ppb
2-Ethylhexyl Acrylate	16-180 ppb

Some specific published odor threshold values are shown below.

Air dilution threshold values in vol/vol ppb<sup>2</sup>:

Methyl Acrylate	4.8 ppb
Ethyl Acrylate	1.2 ppb
n-Butyl Acrylate	35 ppb

Minimum detection and 100% Recognition levels<sup>3</sup>:

Ethyl Acrylate	0.2 ppb	0.36 ppb
2-Ethylhexyl Acrylate	73 ppb	180 ppb

The odor threshold values shown above represent the full range of available data given in references 1-3. Lack of full validation creates some uncertainty in these odor threshold values. To increase the likelihood that your odor avoidance or abatement goals are accomplished, it is suggested that the lowest number in the odor threshold ranges be used for design purposes.

Careless handling could also result in releases, which may elicit complaints from neighbors because of the low odor thresholds. In addition, the odor of acrylate monomers necessitates judicious selection of methods for waste disposal (see Section 10.4).

## 2.2 REACTIVITY

Properly inhibited, these acrylates are stable under recommended storage conditions. The period of stability decreases with increasing temperature. Higher temperatures may cause hazardous polymerization. Contact with strong acids, oxidizing agents, polymerization initiators, heat or flame, sunlight, X-ray or ultraviolet radiation should be avoided (see Section 13).

The following physical values were taken from DIPPR (Design Institute for Physical Properties) where possible. DIPPR is a subsection of AIChE and specializes in compiling physical property data banks for various chemicals.

**Table 3-1: Properties and Characteristics of Acrylate Esters**

Properties	Methyl Acrylate	Ethyl Acrylate	n-Butyl Acrylate	2-Ethylhexyl Acrylate	Reference
Formula Weight	86.09	100.12	128.17	184.28	4
Physical State	Liquid	Liquid	Liquid	Liquid	
Color	Colorless	Colorless	Colorless	Colorless	
Odor	Acrid	Acrid	Sweet	Pleasant	
Odor Threshold (detect), ppb	3-20	0.2-1.3	0.9-100	16-180	1, 8
Density at 20°C, g/cm <sup>3</sup>	0.954	0.923	0.900	0.885	5
Evaporation Rate (n-butyl acetate = 1)	3.5	3.3	0.4	0.03	4
Solubility at 25°C, g/100g in water water in	5.0 2.5	1.5 1.5	0.20 0.70	0.01 0.15	6
Hygroscopicity	Is hygroscopic	Is hygroscopic	Is hygroscopic	Is hygroscopic	
Flammable Limits in air at 25°C Lower Limit, vol% Upper Limit, vol%	2.5 12.0	1.1 14.0	1.3 9.9	See footnote (a) See footnote (a)	7
Flash Point, °C Tag Closed Cup Tag Open Cup	-3 -2	9 19	41 47	87 92	6
Autoignition Temperature, °C	468	383	293	252	4
Boiling Point, °C 760 mm Hg	80	100	147	216 (decomposes)	4
Vapor Pressure, mm Hg at 20°C	68.4	28.8	4.0	0.12	4
Freezing Point, °C	<-76	-71	-65	<-76	4
Critical Pressure, atm	42	36	29	20	4
Critical Temperature, °C	263	280	325	382	4
Vapor Density (air =1)	2.9	3.5	4.4	6.4	7
Viscosity at 25°C, centipoise	0.49	0.55	0.81	1.54	6
Heat of Combustion at 25°C, cal/g	-5359	-6099	-7030	-8068	5
Heat of Polymerization, Kcal/mol	20.2	18.6	18.6	14.4	6

(a) Vapor pressure at 25°C is such that the fuel concentration is too low to support combustion.

(Continued on next page)

**Table 3-1: Properties and Characteristics of Acrylate Esters (Continued)**

Properties	Methyl Acrylate	Ethyl Acrylate	n-Butyl Acrylate	2-Ethylhexyl Acrylate	Reference
Heat of Vaporization, cal/g at normal bp	89.3	80.9	73.0	60.2	4
Specific Heat at 25°C, cal/g/°C	0.45	0.41	0.47	0.40 (extrapolated beyond allowed range)	4
Electrical Conductivity	essentially nonconductive	essentially nonconductive	essentially nonconductive	essentially nonconductive	
Thermal Conductivity, W/m/K at 20°C	0.158	0.147	0.137	0.118	4
100°C	0.130	0.122	0.117	0.103	
Refractive Index at 20°C	1.4040	1.4068	1.4190	1.4365	5
Surface Tension in air at 20°C, dynes/cm	25.7	25.3	26.6	27.1	4
Electrical Group Classification	Class I, Div.II, Grp.D	Class I, Div.II, Grp.D	Class I, Div.II, Grp.D	Class I, Div.II, Grp.D	
Light Sensitivity	Light promotes polymerization	Light promotes polymerization	Light promotes polymerization	Light promotes polymerization	
Reactivity	Highly reactive with itself and wide variety of chemicals. Stable when properly inhibited and stored.	Highly reactive with itself and wide variety of chemicals. Stable when properly inhibited and stored.	Highly reactive with itself and wide variety of chemicals. Stable when properly inhibited and stored.	Highly reactive with itself and wide variety of chemicals. Stable when properly inhibited and stored.	
NFPA Hazard Classification (Health, Flammability, Reactivity)	2-3-2	3-3-2	2-2-2	2-2-2	



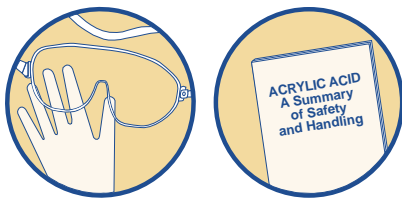

## 4 SAFETY AND HANDLING MANAGEMENT SYSTEM

---

### 4.1 GENERAL CONSIDERATIONS

Safety and handling programs must comply with all regulations applicable to the geographic location of the facility. An example is the Occupational Safety and Health Administration's (OSHA's) Hazard Communication Standard (29 CFR 1910.1200). It is also recommended that Responsible Care® principles be followed.

The hazardous nature of equipment preparation and cleaning requires a qualified multifunctional team to plan each step of the job and consider all possible hazards (see Section 8). It is important that acrylate facilities be designed by qualified professionals who are aware of the special hazards and industry standards (see Section 7). For employees engaged in tasks where the risk of exposure exists, consideration should be given to providing a radio or other means with which to call for assistance.

### 4.2 SAFETY, HEALTH AND ENVIRONMENTAL REVIEWS

Appropriate multifunctional teams should conduct risk assessments as part of the engineering and construction project for new or modified bulk storage and unloading facilities. It is suggested that these teams also address commissioning and start-up of the facilities. Your acrylates supplier can provide appropriate MSDSs, brochures, videos, and other information.

A typical review team utilizes expertise from operations; engineering; construction; technology; and safety, health, and environmental functions. The potential hazards, as well as accident prevention and emergency response should all be discussed by multifunctional teams and the teams should ensure appropriate documentation. It is recommended that the multifunctional teams also address odor control.

### 4.3 WRITTEN OPERATING PROCEDURES

Written operating procedures should give stepwise directions to employees and contractors involved in handling acrylates. These procedures should be written by qualified personnel and reviewed by a multifunctional team. The stepwise directions normally include concise descriptions of the hazards and environmental concerns related to each step. It is suggested that all involved personnel receive documented training on the operating procedures (see Section 4.4).

A management-of-change program should be put in place to help ensure that all changes are properly reviewed and documented before implementation.

### 4.4 DOCUMENTED TRAINING PROGRAM

All employees and contractors who handle acrylates should be thoroughly trained in the potential hazards, accident prevention techniques, emergency response plans, personal protective equipment, and environmental protection considerations which are relevant to their jobs. MSDSs, the ICSHAM training video "Safety and Handling of Acrylates," ICSHAM transportation pamphlets, and guidance from a supplier are suggested training aids.

Documented training is necessary for maintaining a good safety, health, and environmental program. An effective training program ensures that new personnel are adequately trained for their job duties and that changes are communicated to those affected. Awareness of safety, health, and environmental issues should be promoted, affected personnel should have the opportunity to make suggestions, and accidents should be thoroughly reviewed.

Regularly held meetings which cover safety, health, and environmental issues are an essential part of training. All related hazards, incidents, and suggestions should be periodically reviewed in these meetings and attendance should be documented.

### 4.5 WRITTEN EMERGENCY RESPONSE PLANS

Written emergency response plans are recommended for potential spills, fires and inadvertent polymerizations (see Section 11). These emergency response plans should be written by qualified personnel and reviewed by a multifunctional team. Your acrylates supplier may be able to provide additional information.

The written emergency response plans should be periodically reviewed and updated by a multifunctional team. These emergency response plans should be included in safety, health, and environmental reviews and made part of the documented training program. Documented drills are suggested as part of the emergency training program.

Corrective action and communication should always be addressed in the written emergency response plans. In the event of a significant incident, your supplier may be able to provide advice and information. Your supplier can be reached directly or by calling CHEMTREC at 800-424-9300. CHEMTREC should always be contacted if a transport vessel is involved.

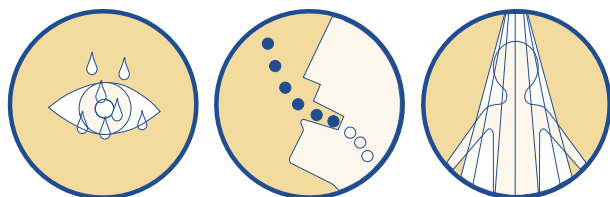

## 5 HEALTH AND SAFETY INFORMATION

---

### 5.1 TOXICOLOGY

#### 5.1.1 General

Acrylate esters are liquids at room temperature and pressure. They can burn mucous membranes and possibly underlying tissues when inhaled or swallowed, even in low concentrations. Contact with the liquid can cause severe burns of the skin and/or eyes, and possibly cause permanent eye damage. The American Conference of Governmental Industrial Hygienists (ACGIH) has Threshold Limit Values (TLVs<sup>®</sup>) of 2, 5 and 2 ppm for eight hour time-weighted averages for methyl, ethyl and n-butyl acrylates, respectively, with skin notations for methyl and ethyl acrylate. Equilibrium concentrations of acrylate vapor in air at room temperature can far exceed these values.

#### 5.1.2 Acute Exposure

Ingestion of acrylic esters is not a common route of human exposure. Ingestion may cause severe irritation or chemical burns of the mouth, throat, esophagus and stomach. Acrylates are considered to be moderately toxic by ingestion and may cause nausea, vomiting, and abdominal pain.

Vapor may cause irritation to respiratory tract. High exposure could result in pulmonary edema. Inhalation of mists or aerosols could result in irritation, drowsiness and headache.

All of the acrylate esters are strong irritants and prolonged exposure may result in burns and blister formation. Ethyl and n-butyl acrylates may also be absorbed through the skin in significant quantities as a result of prolonged skin contact. All four acrylates are known to cause allergic skin reactions in sensitized individuals.

Acrylates are considered to be eye irritants and may cause redness and swelling. Eye contact with the liquid can result in severe corneal burns and may result in irreversible injury.

#### 5.1.3 Chronic Exposure

Long-term exposures to nonirritant levels (amounts that comply with your supplier's allowable exposure levels) of the acrylates are not expected to cause carcinogenic, reproductive or other adverse effects. 2-Ethylhexyl acrylate caused skin cancer when applied to the skin of mice for long periods at irritating doses.

Ethyl acrylate has been tested in laboratory animals via ingestion. While exposures in drinking water did not cause carcinogenic, reproductive or other adverse effects, dosing by gavage caused fore-stomach lesions as a result of irritation caused by large doses. No other adverse effects were noted. As a result, the International Agency for Research on Cancer (IARC) classifies ethyl acrylate as "possibly carcinogenic to humans." Based on the site-specific gastric irritation caused by ethyl acrylate, the U.S. National Toxicology Program (NTP) delisted a similar classification. IARC is also considering withdrawing their cancer classification. For additional information on chronic toxicity of all acrylates, review your supplier's Material Safety Data Sheets (MSDSs) or contact your supplier.

### 5.2 INDUSTRIAL HYGIENE

#### 5.2.1 General

At this time, the American Conference of Governmental Industrial Hygienists (ACGIH) has adopted official Threshold Limit Values (TLVs<sup>®</sup>) of 2, 5 and 2 ppm, 8-hour time-weighted averages for methyl, ethyl and n-butyl acrylates, respectively,

with skin notations for methyl and ethyl acrylates and an A-2 (Suspected Human Carcinogen) designation for ethyl acrylate. The ACGIH further recommends a 15 ppm maximum short term exposure limit (STEL) for ethyl acrylate.

The Occupational Safety and Health Administration (OSHA) has established standards of 10, 5 and 10 ppm, 8-hour time-weighted averages for methyl, ethyl and n-butyl acrylates, respectively, with skin notations for methyl and ethyl acrylates. OSHA also has a 15 minute STEL of 25 ppm for ethyl acrylate. No standards have been established by the ACGIH or OSHA for 2-ethylhexyl acrylate. Refer to your supplier's MSDS or contact your supplier for up to date guidance.

Supplied air respirators or self-contained breathing apparatus (SCBA) approved by the National Institute for Occupational Safety and Health (NIOSH) should be used in case of an emergency when exposures to high concentrations of the acrylates may occur. Air purifying respirators with organic vapor cartridges may be satisfactory for exposure to low level concentrations.

The acrylates should always be handled in well ventilated places or in completely closed systems. In the event of a release of an acrylate, the area should be evacuated immediately and should be entered only by properly trained personnel equipped with appropriate safety equipment. It is advisable to have several sets of safety equipment available at all times, stored outside of, but near, the area where the acrylates are used. Full protective clothing (see Section 5.5) must be worn for work involving line breaking or entering into an acrylate system.

### **5.2.2 Personal Hygiene**

Workers should be warned to avoid breathing acrylate vapors. Appropriate respiratory protection should be used when exposure to acrylate vapors or mists may occur. Workers should be familiar with the location and operation of respiratory protective equipment. They should be instructed to immediately report any incident in which an acrylate vapor was inhaled. Safety showers and eyewash facilities should be provided in close proximity to where acrylates are being handled. Workers should be aware that if any acrylate gets on the skin, they must promptly wash the exposed areas with copious amounts of water. All contaminated clothing and footwear must be removed immediately. Contaminated shoes and other leather items must be properly disposed of. All contaminated clothing must be properly decontaminated (laundered) before reuse. Under no circumstances should contaminated clothing be taken home for laundering. Where decontamination is not feasible, clothing should be properly disposed of.

## **5.3 MEDICAL MANAGEMENT**

Medical management should determine an employee's fitness to work with or around acrylates and establish procedures to be followed if an exposure incident occurs.

All employees should be evaluated prior to working in a chemical environment. This evaluation should include vision testing and respiratory clearance. Overall fitness needs to be confirmed so that the employees are able to safely perform the jobs for which they are being hired.

Contact lenses are not recommended for use in areas where there is a potential for exposure to acrylates. Please see Sections 5.1.2 on acute exposure and 5.5.2 on eye protection for assistance in developing policies and procedures. Since the use of respiratory protection may be required in the work area, respiratory fitness must be evaluated regularly to determine the employees' ability to wear a respirator.

## **5.4 FIRST AID**

### **5.4.1 General**

Every employee working in a potentially dangerous environment (with chemicals, machinery, etc.) should know a few basic first aid steps to follow in case of emergency. In the event of an emergency, it is important that the scene be surveyed to determine what occurred, and to ensure that there is no danger to the person providing assistance. The location of all emergency eyewash stations and showers should be known. The phone number(s) to call for emergency medical services and all workplace-specific emergency procedures should be readily accessible.

When providing first aid to a person who has been exposed to acrylates, the victim should be removed from the area to prevent further exposure. The type of exposure the person has experienced should be determined – eye or skin contact, inhalation or ingestion. If possible, do not leave an injured person alone. A co-worker should be instructed to call for help while assistance is being provided to the affected individual.

In the event of an accidental exposure to acrylates while working alone, the worker should leave the area. After finding a co-worker and instructing him/her to call for help, the exposed worker should follow procedures to remove or dilute the contamination. Basic first aid procedures for acrylates exposure are given in 5.4.2 through 5.4.5.

#### 5.4.2 Contact with Eyes

In case of eye exposure to acrylates at any concentration, the person should immediately go to the nearest eyewash station and flush his/her eyes with water for at least 15 minutes while holding eyelids open and away from the eyes. The exposed individual should be evaluated by a physician as soon as possible due to the potential for serious harm. If a physician is not immediately available, the process of flushing the eyes with water should be continued for a second 15 minute period. Do not put any ointments or medications in a person's eyes unless specifically instructed by a physician.

#### 5.4.3 Contact with Skin

If acrylates come in contact with a person's skin or clothing, the individual should immediately go to the nearest safety shower and rinse off the acrylates. Once under the shower, all contaminated clothing and shoes should be removed. The affected area(s) of the person should be washed continuously with large quantities of water for at least 15 minutes or longer if acrylate odor persists. The exposed individual should be evaluated by a physician as soon as possible due to the potential for serious harm. No ointments or medications should be applied to the skin without specific instruction from a physician.

**ALL CONTAMINATED CLOTHING MUST BE APPROPRIATELY DE-CONTAMINATED PRIOR TO RE-USE. DO NOT TAKE CONTAMINATED ITEMS HOME FOR LAUNDERING! IF THE FACILITY IS NOT EQUIPPED TO DECONTAMINATE CLOTHING AND OTHER ITEMS, THEY SHOULD BE PROPERLY DISPOSED OF AND REPLACED. CONTAMINATED LEATHER ITEMS CANNOT BE ADEQUATELY DECONTAMINATED AND SHOULD BE DISCARDED.**

#### 5.4.4 Inhalation

If acrylate vapors are inhaled, the affected person should immediately be removed from the contaminated area to a well ventilated area. The exposed individual should be evaluated by a physician as soon as possible due to the potential for serious harm. Oxygen is often administered as first aid for persons who have inhaled acrylates. Oxygen should never be administered by untrained individuals – wait for emergency medical assistance.

##### 5.4.4.1 *Suggestions to Physicians*

Oxygen has been found useful in the treatment of inhalation exposures of many chemicals, especially those capable of causing either immediate or delayed harmful effects to the lungs, such as acrylates. Any treatment should be carried out at the discretion of a physician.

In most exposures, administration of oxygen at atmospheric pressure has been found to be adequate. This is best accomplished by use of a face mask with a reservoir bag of the non-rebreathing type. Inhalation of pure oxygen (100 percent) should not exceed one hour of continuous treatment. After each hour, therapy may be interrupted. It may be reinstated as the clinical condition indicates.

In the event of symptoms caused by exposure to acrylates, or in the case of a history of severe exposure, the patient may be treated with oxygen under 0.4 kPa (4 cm [1.5 in.] of water) exhalation pressure for one-half hour periods out of every hour. Treatment may be continued in this way until symptoms subside or other clinical indications for interruption appear. **IT MAY NOT BE ADVISABLE TO ADMINISTER OXYGEN UNDER POSITIVE PRESSURE IN THE PRESENCE OF IMPENDING OR EXISTING CARDIOVASCULAR FAILURE.**

#### 5.4.5 Ingestion

Ingestion of any quantity of acrylates should be treated by having the person drink 4 to 8 ounces of water (latest information from poison control centers, as drinking large quantities of water could actually induce vomiting). **DO NOT INDUCE VOMITING.** Vomiting can potentially cause burns to the esophagus and other internal organs. Immediately contact local emergency medical services or the local poison control center for assistance. The exposed individual should be evaluated by a physician as soon as possible due to the potential for serious harm.

### 5.5 PERSONAL PROTECTIVE EQUIPMENT

#### 5.5.1 General

Full protective clothing should be considered as follows: a chemical resistant splash suit, gloves, boots, eye protection, and respiratory protection. Personal protective equipment (PPE) should be selected based on the potential for exposure to a particular chemical(s), and the unique properties of that chemical. The Occupational Safety and Health Administration (OSHA) regulates the selection and use of PPE in 29 CFR 1910, Subpart I, Sections 1910.132-138, and

Appendices A and B. In general, PPE is not an adequate substitute for appropriate workplace controls (such as ventilation), or other safe work practices. There may be situations when the only practical means of preventing employee exposure is through the effective use of PPE. Personal protective equipment<sup>9,10</sup> should be selected on the basis of potential exposure. When PPE is provided to employees, they must be trained in how, where, when, and why the equipment should be used. The facility must also have provisions for decontaminating and replacing such equipment as necessary.

### 5.5.2 Eye Protection

Eye protection in the form of chemical splash goggles should be worn to prevent acrylates from accidentally splashing in an employee's eyes. Goggles should be non-vented and designed specifically to protect against chemical splash. If an employee wears corrective lenses, chemical goggles should be worn over the lenses. Contact lenses are not recommended for use in areas where there is a potential for exposure to acrylates. Vapors can collect behind contact lenses and may cause severe damage to the eye and/or cause the contact lenses to adhere to the eyes.

### 5.5.3 Skin Protection

Skin protection may be found in many forms. Hand protection, such as chemical resistant gloves, protective arm sleeves, aprons, full body coveralls, boots, and head coverings are among the types available. Skin protection must be made of a material impervious to acrylates. Butyl rubber of 0.4 to 0.6 mm (15.7 to 23.6 mils) thickness is a good example; nitrile could be acceptable for short-duration tasks. Polyethylene-polyvinyl alcohol laminate gloves (0.08mm, 3 mils) were found to offer the greatest level of protection against acrylates in a 1999 study of chemical-resistant gloves sponsored by BAMM.<sup>11</sup>

Skin protection for the purpose of preventing chemical exposure may be worn in conjunction with other types of PPE. For example, steel toe safety shoes may be required to prevent a person's foot from being crushed, but an additional boot cover may be required to prevent acrylate permeation into the safety shoe.

Skin protection PPE is available in a variety of sizes, and should be available in a size that fits the employee wearing it. Improperly sized PPE may compromise its effectiveness and create additional safety hazards. When skin protection PPE is used, there must be a means of cleaning or disposal/replacement of the PPE. In the event of permeation, gloves and other PPE should be replaced, and the chemically-contacted materials properly disposed of as a contaminated waste.

### 5.5.4 Respiratory Protection

Respiratory protection is available in two basic varieties: air purifying, and air supplied. In general, air purifying respirators (fitted with organic vapor cartridges) provide less protection than air supplied respirators. Both types, however, have their particular advantages and limitations. The appropriate type of respirator must be selected to provide the appropriate level of protection for the anticipated degree of exposure to airborne acrylates (vapor or mist). Detailed guidance for the selection of respiratory protection can be found in The American National Standards Institute Document Z88.2.

Respiratory protective equipment should be approved by NIOSH. It must be carefully maintained, inspected, and cleaned. All employees required to wear respiratory protection must be medically cleared to do so (this ensures their physical capability to wear a respirator) and trained to use and care for the equipment. OSHA requirements for respiratory protection can be found in 29 CFR 1910.134.

### 5.5.5 Head Protection

Hard hats are recommended for protection from falling objects, overhead liquid leaks, and chemical splashes.

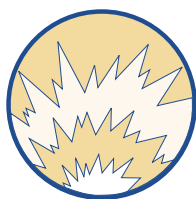

## 6 INSTABILITY AND REACTIVITY HAZARDS

---

### 6.1 POLYMERIZATION

Acrylates are stable when stored and handled under recommended conditions. Commercially available acrylates are stabilized (inhibited) with hydroquinone monomethyl ether (MEHQ), which prolongs the shelf life, i.e., the time before

spontaneous polymerization occurs. However, this shelf life is reduced exponentially with increasing temperature<sup>12</sup>. Exposure to high temperatures, therefore, must be avoided (see Section 11.1.2).

Unlike their parent acid, acrylic acid, acrylate esters do not undergo spontaneous dimerization.

The polymerization of acrylates can be very violent, evolving considerable heat and pressure and ejecting hot vapor and polymer, which may autoignite. An explosion hazard exists due to extremely rapid pressure build up. Several case histories are known in which vessels of acrylates exploded due to violent (“runaway”) polymerization when proper procedures were not followed.

Causes of polymerization are overheating, contamination with incompatible chemicals, or the removal of oxygen<sup>13</sup>.

The presence of dissolved oxygen is necessary for MEHQ to function effectively<sup>14-16</sup>. Thus, acrylates should never be handled or stored under an oxygen-free atmosphere. A gas mixture containing 5 to 21 vol. percent of oxygen at one atmosphere should always be maintained above the monomer to ensure inhibitor effectiveness. In a closed system, this atmosphere must be periodically replenished since dissolved oxygen is gradually consumed in the inhibition process, forming oligomeric peroxides. Acrylates being loaded into drums, rail cars, or tank trucks must have a concentration of dissolved oxygen equivalent to saturation with one atmosphere of a gas containing 5 to 21 vol. percent of oxygen. Residues in transfer lines and other stagnant areas should be blown out with a gas mixture containing 5 to 21 vol. percent of oxygen. If acrylates are used in a facility which is not a chemical plant as defined in 29 CFR 1910.106, the use of air as a motive gas may be restricted.

If acrylates have been inadvertently overheated, contaminated, or over-aged, a determination of the MEHQ concentration may be desired. This analysis should be carried out by gas or high performance liquid chromatography (GC or HPLC) rather than by nitrite colorimetry (contact your supplier for method details). The nitrite colorimetric method (ASTM D-3125) erroneously identifies some MEHQ degradation products (which are not necessarily active inhibitors) as MEHQ. It must be remembered that a correct MEHQ concentration is necessary **BUT NOT SUFFICIENT** for adequate stability. Other factors influencing stability are concentration of dissolved oxygen and of oligomeric peroxides, which may form during aging of the monomer. These are some of the contributing factors which dictate the one year shelf life of the monomer.

Good housekeeping and engineering must be exercised to strictly avoid contamination of acrylates. Many impurities promote acrylate polymerization, such as peroxides and peroxide-forming compounds and free-radical-generating compounds (e.g., hydroperoxides, aldehydes, ethers, azo compounds, etc.). Other classes of compounds, such as strong acids and oxidizing agents are not free radical generators, but if added to acrylates, can sometimes initiate thermal polymerization through their heat of reaction. The Appendix (Section 13) lists other materials that are incompatible with acrylates.

Acrylate tanks should be protected from mistakenly being charged with other materials or from back flowing liquids from production vessels. This can best be achieved by using dedicated loading and unloading lines with proper identification.

A common location for inadvertent polymerization due to contamination is a “slop” container, i.e., a container for holding various waste materials to be disposed of later. Often, the chemicals added to the slop container are not monitored or controlled and the resulting mixture may contain acrylates and a polymerization initiator or other incompatible substances. Careful monitoring and control of materials going into the slop container will avoid this potentially dangerous condition.

Preventing unsafe conditions through proper design and operation of acrylates storage facilities is the best method of avoiding an inadvertent polymerization. The fundamental elements of a well designed storage system are: redundant temperature monitoring, recirculation of the acrylates, use of an oxygen-containing blanket gas, and dedicated piping and equipment. A properly designed facility coupled with a safe operating discipline will provide the user with a reliable storage system. However, even the best designed system may not totally guarantee the absence of incidents, so additional protection may be desired. Restabilization or “shortstop” systems can sometimes be used to prevent or mitigate an inadvertent polymerization<sup>17</sup> (see Section 11).

## 6.2 FLAMMABILITY

According to the National Fire Protection Association (NFPA), methyl and ethyl acrylates are Class IB flammable liquids (NFPA 30). They are also given a flammability rating of 3 (NFPA 325M). Department of Transportation (DOT) regulations require posting of “FLAMMABLE LIQUID” labels on shipping containers and “FLAMMABLE” placards on vehicles. n-Butyl acrylate and 2-ethylhexyl acrylate are classed as combustible liquids by NFPA and are given flammability ratings of 2. However, n-butyl acrylate is classified as a “FLAMMABLE LIQUID” by DOT and requires a “FLAMMABLE” placard on vehicles. 2-Ethylhexyl acrylate requires a “COMBUSTIBLE” placard on vehicles.

Flame arresters must be approved by the Bureau of Fire Underwriters. The installation of flame arresters on tanks holding flammable liquids may be required by federal, state or local ordinance or by insurance companies. For increased safety, flame arresters may be installed in any vapor (vent) line which can be opened directly to the atmosphere with the exception of the emergency vent. When using closed circuit unloading, an additional flame arrester should be installed

in the vapor line. Flame arresters should be inspected at least once every six months for blockage by polymer.

Electrical installations in Class I hazardous locations, as defined in Article 500 of the National Electrical Code, should be in compliance with Article 501 of the Code. Electrical equipment should be suitable for use in atmospheres containing acrylate vapors. See Flammable and Combustible Liquids Code (NFPA 30), National Electrical Code (NFPA 70), Static Electricity (NFPA 77) and Fire Hazard Properties of Flammable Liquids, Gases and Volatile Solids (NFPA 325M).

All installations and procedures must conform with federal, state and local ordinances and the regulations of underwriters and insurance companies.

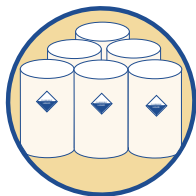

## 7 BULK STORAGE FACILITIES AND ACCESSORIES

---

### 7.1 GENERAL CONSIDERATIONS

It is an acceptable practice to store acrylates at ambient temperatures. The most common tank design follows the American Petroleum Institute (API) standards. This design incorporates a vertical shell, a flat bottom and a conical top. Tanks can be constructed of steel, baked phenolic-lined steel or stainless steel. Steel tanks are the most common due to cost considerations. Tanks are usually set on a concrete pad within a concrete dike of sufficient capacity and have a tank well with a bottom drain line to allow complete tank drainage. Alternative designs include underground tanks and horizontal cylinder tanks mounted on concrete saddles. Tanks used in acrylate service are sometimes painted white to minimize heat absorption and are well grounded electrically. The electrical resistance between the tank and ground must not exceed 5 ohms.

The optimum capacity of an acrylate storage tank is a function of the transportation mode, the expected consumption rate, the expected frequency of deliveries and the monomer shelf life. For the most efficient scheduling of truck deliveries, storage tanks should be at least 1.5 times the volume of the expected delivery.

MEHQ inhibited methyl, ethyl, n-butyl, and 2-ethylhexyl acrylates require the presence of dissolved oxygen to maintain stability (see Section 6.1). Therefore, an atmosphere containing 5 to 21 vol. percent of oxygen should be maintained above the acrylate. **NEVER USE AN "INERT" (OXYGEN-FREE) ATMOSPHERE.** Typically a 10 percent void volume in acrylate bulk storage vessels is used as a buffer against tank overflow. This also provides adequate oxygen containing gas to activate the MEHQ inhibitor. In addition, acrylates are hygroscopic. A means of excluding moisture may be provided to prevent contamination of the monomer. Higher concentrations of water which lead to the formation of an aqueous phase may cause polymer formation.

Methyl and ethyl acrylates readily form and n-butyl acrylate may form flammable mixtures with air at ambient temperatures. Therefore it is recommended that flame arresters be considered and precautions be taken to minimize the risk of static discharge and other potential sources of ignition (see section 6.2). The risk of flammability can be further minimized by reducing the oxygen content in the atmosphere (to not less than 5 percent) or in some cases, by reducing the monomer temperature to lower the vapor pressure. **ALWAYS INSURE THAT THE ATMOSPHERE ABOVE THE ACRYLATE CONTAINS AT LEAST 5 PERCENT OXYGEN BY VOLUME.**

Avoid condensation in vent lines and nozzles. Condensed acrylates can quickly polymerize due to a lack of inhibitor. Vent lines should be sloped to allow drainage whenever possible. **POLYMERIZATION IN VENT SYSTEMS CAN LEAD TO DANGEROUS PLUGGING AND THE FAILURE OF PRESSURE OR VACUUM RELIEF SYSTEMS.**

Take every precaution to keep acrylates free of contamination, by using dedicated equipment and lines, for example. **EVEN TRACE CONTAMINATION WITH AN INITIATOR CAN LEAD TO A DANGEROUS POLYMERIZATION** (see Section 6.1).

Never store or handle acrylates in a facility without first carefully reviewing the design of all vessels and accessories for potential hazards (see Section 4.2). **NEVER STORE IN A VESSEL WHERE STEAM CAN ACCIDENTALLY HEAT THE MATERIAL DIRECTLY THROUGH A HEAT TRANSFER SURFACE OR BY DIRECT ADDITION TO THE VESSEL.** Storage in process vessels or in storage tanks designed for other chemicals can lead to unsafe conditions.

**ALL ACRYLATE STORAGE VESSELS (INCLUDING CHARGE OR WEIGH TANKS) SHOULD HAVE A HIGH TEMPERATURE ALARM.** The purpose of this alarm is to detect an inadvertent polymerization or the introduction of excessive heat from external sources. Properly located and maintained redundant temperature probes (minimum 2) connected to a high temperature alarm can provide early warning of potentially unsafe conditions and allow for corrective action.

**ALL ACRYLATE PUMPS THAT COULD POTENTIALLY OVERHEAT IF DEADHEADED (BLOCKED IN) SHOULD BE PROTECTED FROM OVERHEATING.** If deadheaded, many types of pumps can quickly overheat and cause a violent polymerization, which could result in serious injury and/or loss of property.

Periodically inspect vent nozzles and lines for polymer. Promptly remove any polymer found in the system. Polymer can cause plugging and may promote further polymerization under some conditions. It is good practice not to leave stagnant lines or nozzles liquid-full for over one week. Dissolved oxygen is slowly consumed and must be replenished by occasional circulation or clearing the lines with a gas containing 5 to 21 vol. percent of oxygen. Depletion of oxygen can cause polymer formation and plugging.

Acrylate vapors are highly odorous even at very low concentrations. At higher concentrations, acrylate vapors can create health and flammability hazards (see Section 2.1). **ODORS MUST BE MINIMIZED BY HAVING WELL MAINTAINED CONTROL DEVICES IN PLACE AND BY FOLLOWING GOOD OPERATING PROCEDURES.**

Indoor acrylate storage facilities must be well ventilated to prevent local accumulation of vapors.

### 7.1.1 Odor Control

Odor control techniques are a necessary part of storing and handling acrylate monomers. Techniques for minimizing odors should be considered for unloading, storage, sampling, and during laboratory work. Effective ways of minimizing odors during an accidental release should also be considered.

Final emission control devices include thermal oxidizers and liquid scrubber systems. An activated carbon bed is frequently used after a scrubber system.

Chemicals are frequently employed to absorb and react with the acrylate monomers. The use of masking agents is not recommended. A typical commercial scrubbing solution is comprised of water, sodium hydroxide, a water soluble amine, and a water soluble alcohol. An example is 20 percent sodium hydroxide, 10 percent diethanolamine, 6 percent isopropyl alcohol, and balance water. With time, the sodium hydroxide causes saponification of the acrylate ester to sodium acrylate and the alcohol. The amine is an accelerator that quickly reacts as a Michael addition reagent. The isopropyl alcohol is a co-solvent that increases the solubility of the acrylate in the aqueous solution. A straight aqueous sodium hydroxide solution can also be used but more residence time and lower gas velocities may be necessary to achieve comparable results.

Activated carbon beds can be installed after a scrubber to help eliminate all odor. **HOWEVER, VENTS THAT COULD CONTAIN HIGH CONCENTRATIONS OF ACRYLATES SHOULD NEVER GO DIRECTLY TO A CARBON BED SINCE THE HEAT OF ADSORPTION COULD CAUSE A FIRE.** Aqueous amine solutions can be used to clean fittings, glassware, and equipment upon opening of closed systems. This includes truck fittings, dip pipes, flex hose fittings, sample devices, etc. Aqueous amine solution can also be used to help minimize odors during an accidental spill. The amine solution is sprayed onto the pool of acrylate by using a liquid applicator. The spill is then cleaned up by immobilizing with a suitable absorbent or with a vacuum truck, depending on the quantity involved. The chemically treated acrylate spill can also be diluted with a large quantity of water and sent directly to a permitted biological treatment facility. Another approach for minimizing odors during a spill is to apply fire fighting foam. The foam helps to blanket the acrylate and prevent the escape of vapor.

Dry break disconnects are frequently used on both liquid and vapor lines to minimize the release of acrylates when flexible transfer hoses are disconnected. The liquid transfer hoses are usually blown out with air or mix gas (5 to 21 vol. percent of oxygen) before disconnecting. Some loading and unloading systems have a vacuum clean out system to minimize odors. Before disconnecting and opening the system, a vacuum is pulled to suck the liquid out and vaporize the remaining liquid film on the interior of the piping system.

Closed sample systems can help to minimize odors. All sample bottles and equipment should be sprayed with an amine solution and wiped down if a film of acrylate is suspected. All sample bottles and equipment brought into the laboratory should be completely odor-free. All open transfers of acrylates must be performed in a vent hood to avoid odors. It is important that contaminated sample bottles and glassware be thoroughly cleaned before being removed from the vent hood.

## 7.2 DESIGN CONSIDERATIONS

Some design considerations for bulk acrylate storage facilities and accessories are given in Sections 7.2.1 through 7.2.12. Table 7-1 summarizes the special recommended design features covered in these Sections. It is recommended that fail-safe positioning of automated valves and emergency backup power for critical instrumentation be included in the design. Follow all codes and regulations applicable to the geographic location of the facility. Design features of an acrylate storage facility are given as examples in Figures 7-1 and 7-2. Contact your acrylate supplier for additional guidance.



### 7.2.1 Temperature Control of Bulk Storage Tanks and Accessories

The common practice is to maintain acrylate storage tanks and piping systems at ambient temperatures (no heating or cooling). However, in some storage systems the acrylate is cooled in order to lower the vapor pressure. Some of the potential advantages of a lower vapor pressure may include reduced flammability risk, less emissions, less risk of odor complaints, and reduced condensation/polymerization in vent lines.

The entire storage and handling system should be designed to prevent accidental exposure to high temperature heat sources such as steam, pumps, solar heat and electrical devices. **EXPOSURE TO HIGH TEMPERATURE HEAT SOURCES CAN RESULT IN A DANGEROUS POLYMERIZATION.**

Small diameter piping systems located outdoors (including valves, pumps and filters) may experience solar heating if left liquid-full for prolonged periods of time in a static state. Potential polymerization problems in such systems can be avoided by periodic circulation, blowing the system with a gas containing 5 to 21 vol. percent of oxygen, or by draining the system. It is also possible to reduce the risk of polymerization problems related to solar heating by covering or insulating piping in order to prevent prolonged exposure to direct sunlight.

All acrylate storage systems should be designed to allow non-routine recirculation as needed. There is some risk that heat introduced by the pump during prolonged recirculation could overheat the acrylate, especially if the system is insulated. Engineering safeguards and operating procedures should be employed to insure that excessive temperatures do not occur during recirculation.

### 7.2.2 Pumps and Protection of Pumps from Overheating

It is recommended that safeguards be provided to prevent accidental overheating of acrylate monomer pumps. **OVERHEATING OF ACRYLATE MONOMER PUMPS CAN CAUSE A POLYMERIZATION, WHICH MAY RESULT IN INJURY AND/OR LOSS OF PROPERTY.** Deadheading (blocking in) a centrifugal pump usually causes a rapid temperature rise inside the pump (consider emergency response capabilities, see Section 11). Some options to help protect pumps from overheating/deadheading are given below (choice of method of deadhead protection may vary from case to case and should be based on a safety analysis).

- A temperature sensor placed inside the pump or close to the discharge/suction which activates alarm and shutdown switches if a high temperature is detected.
- A power monitor that senses a low power consumption and activates an alarm and shutdown switch. Deadheading a centrifugal pump usually results in an immediate reduction in power consumption.
- A flow detection element on the discharge line that activates an alarm and shutdown switch when a low flow is detected can provide deadhead protection.
- Operator training, monitoring and intervention can prevent deadhead situations from occurring, or correct to a safe condition if deadheading does occur.

Other considerations associated with pumping acrylates are given below.

- Double mechanical seal and magnetic drive centrifugal pumps are commonly used for acrylate service. These pumps require instrument interlocks to prevent dangerous overheating in case deadheading accidentally occurs.
- Seals and bearings in contact with acrylates should be flushed for adequate cooling and lubrication. High surface temperatures can cause polymer particles to form.
- Air driven diaphragm pumps are occasionally used for acrylate service. Diaphragm pumps usually stop pumping if deadheaded and may not require instrument interlocks to protect against overheating.
- The use of truck mounted pumps is not recommended for unloading acrylates due to the potential for leaks, overheating, and contamination.
- Some environmental protection guidance related to pumps is given in Section 7.2.7.
- A liquid sensor element placed in the suction line or feed vessel that activates an alarm and shutdown switch when liquid is not detected. This sensor can be used to help avoid running a pump dry **BUT DOES NOT GIVE DEADHEAD PROTECTION.** Many types of pumps quickly overheat if operated dry.

Your supplier may be contacted for additional guidance on the selection and safety of acrylate pumps.

### 7.2.3 Detecting Unsafe Conditions Inside Bulk Storage Vessels

It is highly recommended that all vessels used to store acrylates have two independent temperature probes connected to a high temperature alarm. This includes storage tanks, check tanks, weigh vessels, and charge vessels. The two temperature probes should be located near the bottom of the vessel (preferably 90 to 180 degrees apart) and alarm in the control room in the event that either probe exceeds the high temperature set point. It is also suggested that both temperatures and rates of temperature change be carefully monitored. These temperature probes and alarms are essential for confirming

safe storage conditions and for emergency response to an inadvertent polymerization (see Section 11.1.2). **EARLY DETECTION OF A HIGH TEMPERATURE INSIDE AN ACRYLATES VESSEL CAN FACILITATE TIMELY EMERGENCY RESPONSE TO A DANGEROUS INADVERTENT POLYMERIZATION AND MAY HELP AVOID SERIOUS INJURY AND/OR LOSS OF PROPERTY.**

#### **7.2.4 Avoiding Polymer Formation in Vent Nozzles and Lines**

The polymerization of condensed acrylate monomer vapors in storage tank vent systems can result in dangerous conditions by plugging critical pressure and vacuum relief lines. Liquid acrylate monomer condensed from vapor does not contain MEHQ stabilizer and is prone to form polymer. It is recommended that all critical vent nozzles and lines be routinely inspected for polymer. Any polymer found should be promptly removed. As practical, vent lines should be sloped to drain condensed liquid back to a vessel containing stabilized acrylate monomer. Drain valves should be installed at low points in the vent system where condensed acrylate monomer may accumulate. It is recommended that all drain valves be capped or plugged to minimize the risk of a release.

There are several optional engineering modifications that have proven successful in reducing condensation in vent nozzles and help to minimize the risk of polymer formation. One option is to insulate vent nozzles and lines to help keep the temperature above the dew point. The use of properly designed tracing as well as insulation further minimizes the risk of rapid polymer formation. The choices of heat tracing for vent nozzles/lines include self-limiting electric tracing or the use of a heat transfer fluid of temperature less than 45°C (113°F). Another proven modification is to sweep nozzles that are prone to plug with a small amount of dry, oil-free gas that contains 5 to 21 vol. percent of oxygen. If needed, contact your acrylate monomer supplier for further guidance on minimizing polymer formation in vent systems.

#### **7.2.5 Heating of Liquid Acrylate Monomer**

**HEATING OF LIQUID ACRYLATE MONOMER IN UNLOADING AND STORAGE SYSTEMS IS NOT RECOMMENDED.** Acrylate monomers do not freeze at ambient temperatures. It may be necessary to pre-heat liquid acrylate monomer as part of a chemical processing step. If so, a thorough safety review should be conducted to help insure that an uncontrolled polymerization does not occur. **EXPOSURE OF ACRYLATE MONOMERS TO HIGH TEMPERATURE HEAT SOURCES AND/OR KEEPING ACRYLATE MONOMERS AT ELEVATED TEMPERATURES FOR PROLONGED PERIODS OF TIME CAN BE DANGEROUS.**

#### **7.2.6 Indoor Acrylates Storage Facilities**

All codes and regulations applicable to the geographic location of the facility must be followed. The special risks associated with indoor facilities should be considered during the initial project safety, health and environmental review as well as in all subsequent reviews. In particular, the consequences of spill, fire, and inadvertent polymerization should be carefully considered.

The design of the indoor facility must provide for an odor-free work environment. Indoor acrylate storage facilities must be well ventilated to prevent local accumulation of vapors, which can have potentially harmful effects on personnel. It is suggested that local exhaust systems be considered to supplement the general exhaust system and that adequate air change rates are ensured. It is recommended that all laboratories be provided with a sufficient number of properly designed exhaust hoods. All indoor bulk storage tanks should vent outside of the building.

#### **7.2.7 Engineering Features for Environmental Protection**

All environmental regulations applicable to the geographic location of the facility should be met.

Providing an odor-free environment must be considered when designing a storage and handling facility for acrylates. Releases must be eliminated or minimized during all steps of operation.

Spill containment helps protect public waterways and ground water. Dikes around storage tanks are used to contain spills. Properly designed concrete dikes and flooring which can hold 110 percent of the entire contents of the largest tank are recommended. Spill containment for bulk unloading areas will reduce environmental risks. Concrete containment is suggested for bulk unloading areas. The use of dry disconnect fittings can reduce releases and may help avoid a spill if accidentally opened under pressure. Instrumentation to monitor the liquid level in bulk storage tanks is recommended to help prevent spills.

Vapor return lines are suggested for bulk unloading facilities to reduce emissions (see Section 7.2.10). If needed, scrubbers, incinerators, or thermal oxidation units can be used to control emissions. Local, state, and federal regulations may apply. Contact your supplier for additional guidance.

Magnetic drive and double mechanical seal centrifugal pumps as well as double diaphragm type pumps can reduce fugitive emissions and the risk of spills. Double mechanical seals are commercially available using a liquid (such as a glycol) or a gas (such as oil-free air) as the barrier fluid. Environmental protection should be considered in the selection of pumps.

### 7.2.8 Engineering Considerations for Fire Control

It is highly recommended that engineering safeguards be provided for reducing the risk of an inadvertent polymerization inside of a bulk storage tank during a fire. **AN UNCONTROLLED HEAT SOURCE, SUCH AS A POOL FIRE, CAN CAUSE A VIOLENT POLYMERIZATION RESULTING IN SERIOUS INJURY AND/OR LOSS OF PROPERTY.** See Section 11 on emergency response.

Water monitors are suggested to help control acrylate fires and to cool acrylate containing equipment during a fire. Isolation with dike walls can be used to protect acrylate tanks from pool fires caused by other chemicals.

A foam system can be used to extinguish acrylate fires (see section 11.3).

A restabilization (shortstopping) system can be installed to allow the quick addition of phenothiazine (PTZ) in the event of a fire. Refer to Section 11.1.3 on restabilization. Acrylates containing adequate PTZ are much less likely to polymerize violently during a fire.

#### 7.2.8.1 Mixed Gas Systems

Methyl acrylate and ethyl acrylate are flammable (closed cup flash point less than 140°F). Standard industry handling practice for flammables is to use inert gas (nitrogen) for blowing of lines, pigging operations, and blanketing of tanks. However the MEHQ inhibitor used in acrylates requires the presence of a small amount of dissolved oxygen in the monomer. It is thus recommended that the acrylate be kept in contact with an atmosphere containing 5 to 21 vol. percent oxygen. In some applications, for example where tank vents are collected into a header for incineration, there may be safety concerns that prevent the use of air to blanket flammable acrylate esters. An appropriate safety analysis should be carried out, and applicable regulations for your area and application should be consulted.

To address flammability concerns while maintaining the necessary oxygen for inhibition, a mixture of air and nitrogen may be employed. The limiting oxygen concentration (LOC) is the minimum concentration of oxygen that will propagate a flame in a gas mixture. The LOC of methyl acrylate and ethyl acrylate are approximately 8.5 and 9.0 vol. percent, respectively. To support inhibition, a minimum of 5 vol. percent oxygen has been recommended.

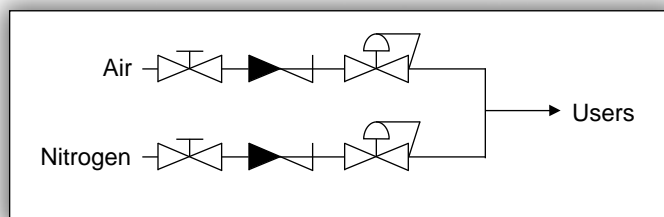

An air-nitrogen mixing station can be designed to yield a gas containing 5 vol. percent oxygen. Equipment measurement tolerances must be carefully considered to ensure the operating range remains comfortably below the LOC and above zero, for example 6.5+/-1.5 vol. percent. The equipment used to implement a mixing station can be simple or complex depending on the application and desired safeguards. A simple system employs regulators on nitrogen and air sources. The regulators are set to deliver the desired ratio of air and nitrogen; 1 part air in 2 parts nitrogen yields approximately 7 vol. percent oxygen in the mixed gas.

More sophisticated air-nitrogen mixing systems may employ oxygen sensors and flow controllers. The oxygen analyzer can feed back into the flow controller and/or an emergency shutdown system. During the system design, careful consideration must be given to the instrumentation failure modes.

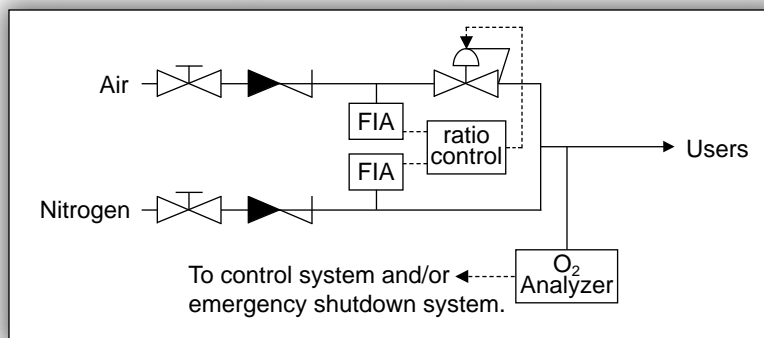

FIA = Flow Indicator

### 7.2.9 Materials for Construction and Sealing in Acrylate Service

Proper choice of materials of construction is important for safety, health, and protection of the environment. Some specific guidance for acrylate service is given below. Contact your supplier for further information.

- Material of construction is usually steel due to cost considerations. Phenolic-lined steel and stainless steel can also be used and may offer advantages in certain applications (see Section 8.3 on commissioning). Carbo-Zinc 11 and Dimetcoat 4 are also considered acceptable coatings for acrylate service.
- Teflon® or graphite-coated metal gaskets are frequently used in acrylate service. This includes spiral-wound Teflon® or graphite-filled gaskets. Graphite is specified when greater fire resistance is needed.
- Other gasket materials used in certain acrylate applications include Silicone no. 65®, EPDM, fawn Gylon®, butyl rubber, white neoprene, or Santoprene®.
- Kalrez® (or equivalent) O-rings are used in a variety of acrylate applications.
- Avoid contact with copper or copper containing alloys. Exposure to copper may result in adverse effects on the monomer properties.

### 7.2.10 Venting of Bulk Storage Tanks

Follow all codes and regulations applicable to the location of the facility.

It is recommended that vacuum and pressure relief valves be installed unless the tank has an open vent to the atmosphere. A combination pressure-vacuum relief valve, sometimes referred to as a conservation vent valve, is frequently employed to help minimize the multiplicity of equipment and nozzles. Routine inspections of the conservation vent system are recommended at least once per year to remove any polymer (see Section 7.2.4) and to ensure operability. The make-up gas supplied must contain 5 to 21 vol. percent of oxygen. Dry, oil-free gas is preferred. The American Petroleum Institute (API) bulletin 2516 provides information related to the design and operation of conservation vents.

It is suggested that vapor return lines be installed to significantly reduce emissions during unloading or loading of transport vessels such as rail cars or tank trucks. These lines should be kept free of polymer and the vent conservation valves correctly adjusted to contain most of the vapors during unloading and loading. Reducing emissions during transfers is an essential element of providing an odor-free environment.

Storage tanks located indoors require venting to the outside of the building.

**IT IS ESSENTIAL THAT INCOMPATIBLE CHEMICALS NOT BE ABLE TO ENTER AN ACRYLATE STORAGE TANK THROUGH THE VENT SYSTEM.**

The need to install flame arresters in vent lines may depend on the applicable regulations and codes of a given region as well as the flash point of the acrylate. Methyl and ethyl acrylates readily form and butyl acrylate may form flammable mixtures with air at ambient temperatures. Precautions should be taken to keep flame arresters free of polymer fouling.

### 7.2.11 Emergency Venting of Bulk Storage Tanks

All codes and regulations applicable to the geographic location in which the facility is located should be followed. Standard practice is to design storage tank emergency venting capacity for the vapor generation rate resulting from a pool fire around the tank. **THIS TYPE OF DEVICE WILL NOT PROVIDE ADEQUATE RELIEF IN THE EVENT OF AN UNCONTROLLED OR RUNAWAY POLYMERIZATION.** Guidelines can be found in OSHA standard 29 CFR 1910.106 and API 2000. Relief valves, weighted pallets, quick release manway covers and rupture disks can all be used to vent the vapor directly generated by a pool fire. If used, an open vent can be sized for the pool fire case. Emergency vent devices should be inspected at least once a year to remove any polymer and to ensure operability. Storage tanks installed indoors should route the emergency vent to the outside. Contact your supplier for additional guidance.

It is recommended that weak seam roofs be used when possible in order to provide maximum venting in case of a violent polymerization.

### 7.2.12 Other Bulk Storage Tank Accessories

A 10 percent minimum void volume of blanket gas containing 5 to 21 vol. percent oxygen should be maintained above the liquid.

Bulk storage tanks typically have either a top entry fill pipe or a side entry nozzle for unloading and circulating the acrylates. Top entry fill pipes are normally tack welded to the bottom to assure static grounding and have an antisiphon hole near the top. Mixing during recirculation can be improved by locating the fill pipe across the tank from the outlet. Side entry nozzles are frequently equipped with an eductor to enhance mixing during circulation. Two eductors are sometimes installed on larger tanks. The nozzle tip must always be submerged when in use to avoid the possibility of forming a stable aerosol and ignition from static charge development. **SUBMERGED NOZZLES AND PIPES CAN PLUG IF NOT FREQUENTLY UTILIZED.**

Level monitoring instrumentation is recommended to avoid spills when filling a storage tank. It is recommended that this level monitoring instrumentation include device(s) which alarm if the tank is filled above or emptied below a safe level. Methyl and ethyl acrylates readily form and butyl acrylate may form flammable mixtures with air at ambient temperatures. When flammable mixtures may be present, it is important that the liquid level be above the pump suction line before starting the pump. Many tanks are also equipped with a high-high level switch, which shuts off the unloading pump before a potential spill. A differential pressure level indicator (bubble type) is frequently used in acrylate service. A dry, oil-free gas containing 5 to 21 vol. percent of oxygen must be used for bubble type level indicators.

Safety showers and eye bath stations are recommended in the unloading and storage tank areas. Take precautions to prevent freezing in these stations as dictated by the local climate.

### 7.2.13 Summary of Special Recommended Design Features for Bulk Acrylates Storage Facilities and Accessories

Table 7-1 summarizes the special recommended design features for bulk acrylates storage facilities and accessories. The table also includes references to the related information given in Sections 6.2 through 7.2.12.

**Table 7-1: Summary of Special Recommended Design Features for Bulk Acrylates Storage Facilities and Accessories**

FEATURE	SECTION REFERENCE
Install flame blocking devices, such as flame arresters, as justified.	6.2
Install control devices as needed to provide an odor-free work environment.	7.1.1
Never provide high temperature heat sources such as steam or uncontrolled electric elements for direct heating of acrylates.	7.1, 7.2.1, 7.2.4
Install two independent temperature probes on all bulk acrylate storage vessels for monitoring the temperature, rate of temperature change and for activating an alarm in the event of a high temperature excursion.	7.1, 7.2.3
Provide reliable engineering safeguards such as redundant instrumentation interlocks to prevent accidental overheating of acrylates by pumps.	7.1, 7.2.2
Take precautions to limit the temperatures of pump seals and bearings in contact with acrylates.	7.2.2
Provide the capability of non-routine circulation in bulk acrylate storage tanks as needed.	7.1, 7.2.1, 7.2.3
Provide gas containing 5 to 21 vol. percent of oxygen (dry, oil-free gas is preferred) for blanketing acrylate storage vessels and for blowing out acrylate lines.	7.1, 7.2.4, 7.2.9, 7.2.10, 7.2.12
Take precautions to minimize potential condensation of acrylate in vent lines. This can cause polymer formation resulting in plugged pressure and/or vacuum relief lines.	7.1, 7.2.4, 7.2.10, 7.11
Provide engineering safeguards to reduce the risk of a violent inadvertent polymerization inside an acrylate bulk storage tank during a fire.	7.1, 7.2.5, 7.2.7
Design bulk acrylate storage facilities and accessories to minimize the risk of an accidental contamination.	7.1, 7.2.10.
Design the piping systems to minimize stagnant pockets of acrylates, which may result in polymerization.	7.1, 7.2.4, 7.2.9
When applicable, address the special reactivity, fire and health hazards inherent to indoor facilities.	7.1, 7.2.1, 7.2.5, 7.2.10, 7.2.11

**Table 7-2: Key to Symbols in Figures 7-1, 7-2, 11-1, and 11-2**

<b>Symbol</b>	<b>Definition</b>
DTAH	Temperature change alarm - high
FAL	Flow alarm - low
FE	Flow element
FI	Flow indicator
FIC	Flow indicator/controller
FY	DCS calculation block circuitry
FQ	Flow totalizer
HE	Heat exchanger
I	Interlock
JAL	Power alarm - low
JR	Power recorder
JSL	Power switch - low
JT	Power transmitter
LAH	Level alarm - high
LAL	Level alarm - low
LALL	Level alarm - low low
LG	Level gauge
LI	Level indicator
LSHH	Level switch - high high (shuts down unloading pump)
PI	Pressure indicator
PIC	Pressure indicator and control
PVRV	Pressure and vacuum relief valve
TAH	Temperature alarm - high
TAHH	Temperature alarm - high high
TC	Temperature control
TE	Temperature element
TI	Temperature indicator
TR	Temperature recorder
TSH	Temperature switch - high (shuts down pump)
V	Vessel

**Figure 7-1: Example of an Acrylate Monomer Storage Facility**

This example illustrates some of the safety features discussed in this booklet. Not all equipment or instrumentation required for operability is shown. See Table 7-2 for key to symbols.

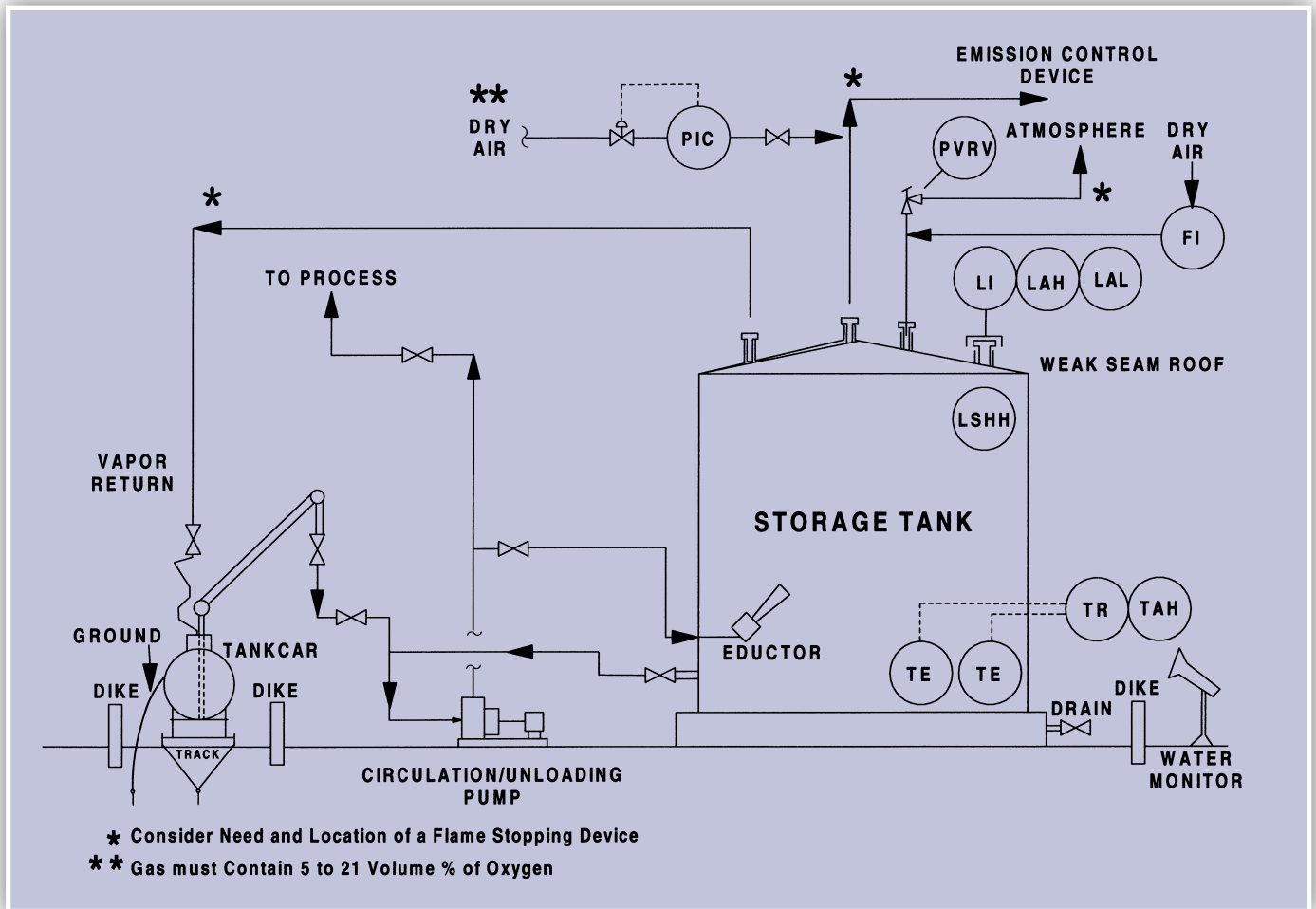

**Figure 7-2: Example of an Acrylate Monomer Pump Loop**

This example illustrates some of the safety features discussed in this booklet. Not all equipment or instrumentation required for operability is shown. See Table 7-2 for key to symbols.

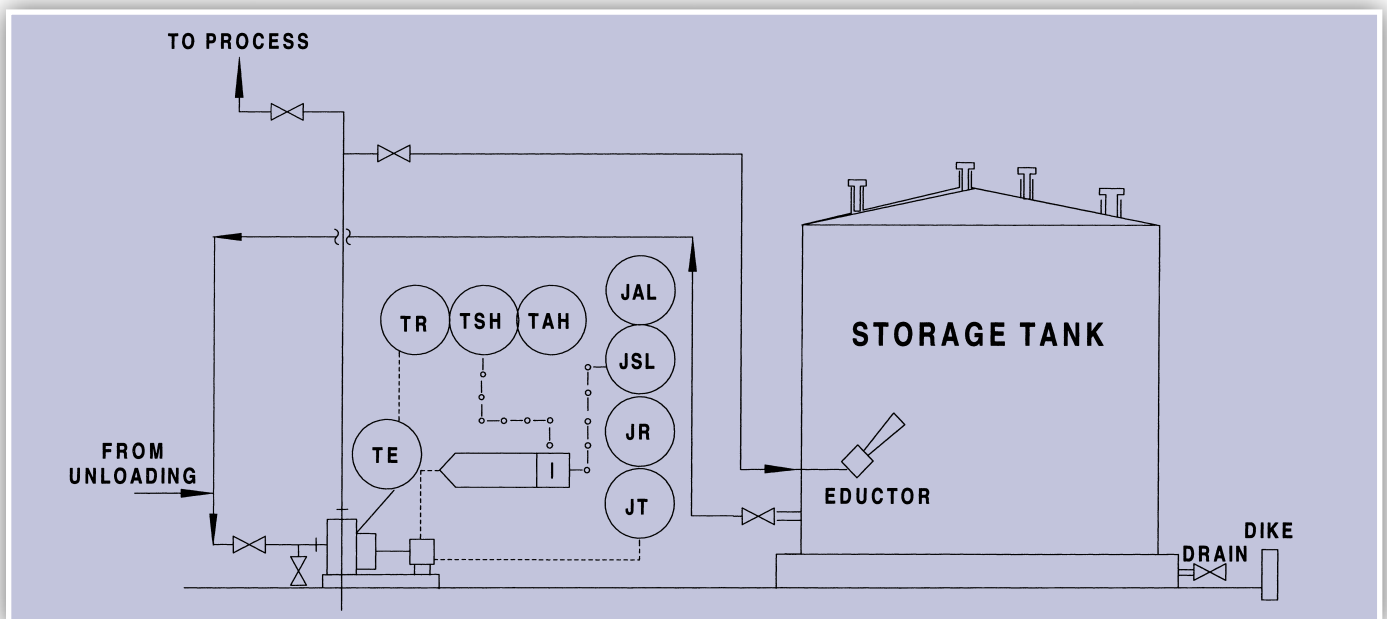

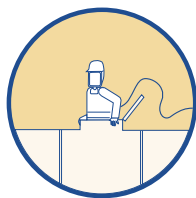

## 8 EQUIPMENT PREPARATION AND CLEANING

---

### 8.1 GENERAL CONSIDERATIONS

The hazardous nature of equipment preparation and cleaning requires that a qualified multifunctional team plan each step of the job in detail and consider all possible hazards. This team should ensure that stepwise safe work procedures are written which clarify hazards, preventive measures and personal protective equipment to be worn at each step.

Equipment preparation and cleaning should be done under the direction of trained personnel who are familiar with the written stepwise safe work procedures. All involved personnel should understand the potential hazards pertaining to the job and the importance of maintaining an odor-free work environment before work is initiated.

### 8.2 PREPARATION OF THE TANK AND EQUIPMENT

The tank or equipment to be cleaned should first be emptied of all liquids. Pipe lines into or out of the tank should be disconnected, preferably by removing a complete small section, provided there is a blank flange on the open end to protect against human error and unsuspected leaks. Valves and blind flanges in the pipe line should not be relied upon alone.

If pipe sections are to be removed and flanges opened, the lower bolts should be loosened first. Wear appropriate PPE to avoid personal contact with any liquid draining or dripping from the equipment. Any spillage from the lines or equipment should be contained, absorbed or removed immediately by flushing with water in compliance with all local regulations and restrictions.

### 8.3 COMMISSIONING ACRYLATES BULK STORAGE FACILITIES

The following are the typical steps included in standard operating procedures for commissioning acrylate bulk storage facilities:

- Break all flanges at equipment. Do not flush through instruments, pump and exchangers.
- Water flush all lines then reassemble equipment.
- Fill tank with high-purity water, checking all possible instrumentation interlocks.
- Perform water run. Run as much of the system as possible to identify problems and tune control loops.
- Drain water from tank and blow/drain all lines.
- Rust can lead to local polymer formation and product discoloration, both of which may adversely affect end use applications. The interior of newly constructed steel tanks should be sand blasted to a white metal and vacuum cleaned to remove rust. If the rust-free steel tank is not soon filled with acrylate monomer, it should be blanketed with dry air or dry mix gas containing 5 to 21 vol. percent of oxygen to retard rusting.
- The rust removal and rust prevention step is not necessary for stainless steel or coated tanks.
- The tank should always be dried and blanketed with a dry gas containing 5 to 21 vol. percent of oxygen before receiving product.
- Do not use incompatible substances, such as nitric acid, for preparing acrylate systems. See Section 6.1 on Polymerization and Section 13.1, the Appendix of Incompatible Materials. Contact your acrylate supplier if additional guidance is needed.

### 8.4 CLEANING ACRYLATE BULK STORAGE FACILITIES FOR DECOMMISSIONING

The following are the typical steps included in standard operating procedures for cleaning acrylate bulk storage facilities for decommissioning (contact your supplier for more information):

- Blow all product from lines and accessories back into tank using a gas with 5 to 21 vol. percent of oxygen. Take precautions not to damage any sensitive equipment.
- Remove product from the tank.
- Flush all lines and accessories with water.



- One or all of the following may be needed to thoroughly remove odorous vapors:
  - Steam all lines and accessories until clean. Take precautions not to damage any sensitive equipment or seals.
  - Wash with 5 to 8 percent caustic to convert the acrylate into less odorous material.
  - Flush with air to an emission control device (see Section 7.1.1).
  - Repeat the above steps as needed to remove odor.
- Wash the tank with 5 to 8 percent caustic if soft polymer is found. Remove caustic solution and rinse thoroughly with water.
- Blast with high pressure water or grit if hard polymer is found. Consider testing integrity of the tank after blasting.
- The tank must be free of odor and tested for flammable vapors, oxygen content and residual caustic (if used) before entering. Follow all applicable regulations concerning vessel entry.
- Dispose of any residual product, polymer, cleaning solutions and rinse solutions at approved facilities.

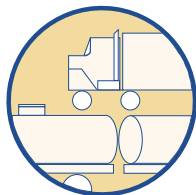

## 9 SAFE TRANSPORT OF ACRYLATES

---

### 9.1 PERSONAL PROTECTIVE EQUIPMENT FOR UNLOADING AND HANDLING

Full protective clothing should be considered as follows: a chemical resistant splash suit, gloves, boots, eye protection, and respiratory protection. Clothing made of supported neoprene, neoprene, or other suitable material should be worn to protect the body against accidental acrylate splashes. Contact lenses substantially increase the risk of damage to eyes and, if your policies permit, should only be worn with special precautions. Full eye protection should include plastic shields with forehead protection in addition to chemical splash goggles. Respiratory protective equipment should be approved by NIOSH.

### 9.2 GENERAL CONSIDERATIONS

The following are general considerations that apply to all modes of transportation for acrylates. See also Section 6 for Instability and Reactivity Hazards.

- Acrylates must be stored in an oxygen-containing atmosphere. The MEHQ inhibitor is not effective in the absence of oxygen.
- Do not use pure oxygen for sparging, blowing lines, or blanketing. Pure oxygen could create a fire hazard.
- Do not use pure nitrogen or any other inert gas for sparging, blowing lines, or blanketing. Pure nitrogen or other oxygen-free gas could reduce the dissolved oxygen to a dangerously low level where the effectiveness of the inhibitor could be greatly reduced.
- Air or a gas mixture with 5 to 21 vol. percent of oxygen are preferred for use in handling acrylates.
- Cleanliness is essential. All containers should be free of contamination.
- Acrylates should never be heated in any way. **PRODUCT TEMPERATURES OF 40°C (104°F) OR HIGHER MAY INDICATE A HAZARDOUS SITUATION AND SHOULD BE IMMEDIATELY INVESTIGATED.**
- Methyl, ethyl and butyl acrylates are classified as “Flammable Liquid” as defined in DOT regulations 49 CFR 172.101. As such, they must be packed in DOT specification containers when shipped. The International Maritime Dangerous Goods Code (IMDG) classification is “Flammable.” International shipping requirements should be reviewed to determine compatibility with United States and IMDG requirements.
- ICSHAM suppliers adhere to all regulations concerning free air space (outage) in filled containers. DOT requires that drums must be filled so that they will not be liquid full at 54°C (130°F). This corresponds to about 3 percent void space (outage) at 25°C (77°F). DOT requires that bulk containers must be loaded so that they have at least 1 percent void volume at 46°C (115°F) for uninsulated tanks and at 41°C (105°F) for insulated tanks. Samples should adhere to the minimum void space requirements for drums. Retained samples should be stored for no more than a year in a cool dark place. Plastic coated amber glass bottles are recommended for handling and storing small amounts of acrylates.
- Non-Bulk Performance Oriented Packaging Standards in DOT 49 CFR 178.500 require testing of non-bulk acrylates shipping containers for Hazard Class, Packing Group, and Subsidiary Hazard Class as shown in Table 9-1. Your sample container supplier can perform testing and guarantee conformance to DOT requirements.

Containers that may test acceptably to DOT requirements for land transportation include the following:

- 1 - Gallon or less
  - Amber glass or steel can or polyethylene jug or bottle with screw cap and polyethylene insert with DOT approved outer packaging (reference 49 CFR 173.202), 4GV/X for all three types of containers.
- 5 - Gallon
  - UN 1A1, steel drum or steel drum with phenolic internal coating
  - UN 1H1, self supporting high density polyethylene drum.

### 9.3 TRANSPORTATION INCIDENTS - IMMEDIATE ACTIONS

**IN THE EVENT OF A SPILL, FIRE OR SUSPECTED POLYMERIZATION, IMMEDIATELY CALL CHEMTREC AT 1-800-424-9300.** CHEMTREC will contact the supplier.

In the event a shipping container (rail car, tank truck, drum, intermediate bulk container [IBC/tote]) becomes damaged so that delivery to destination cannot proceed safely, every effort should be made to park the vehicle where it will not endanger traffic or property, if possible in a vacant lot away from populated areas. The police and fire departments should be notified and the public should be restricted from the area. Immediately contact CHEMTREC at 800-424-9300. CHEMTREC will contact the supplier. Follow precautions stipulated in the supplier's MSDS for acrylates. See Section 11 on Emergency Response for additional information.

#### 9.3.1 Bulk Cargo Temperatures

Acrylates should never be heated in any way. Acrylates are shipped in bulk at ambient temperatures and do not need any special provisions for temperature control. Consequently, it is difficult to state any specific temperature range for a normal acrylate cargo. An abnormally high temperature is an important indicator of a polymerizing cargo. **TEMPERATURES OF 40°C (104°F) OR HIGHER MAY INDICATE A HAZARDOUS SITUATION AND SHOULD BE IMMEDIATELY INVESTIGATED.** What is "abnormal" must be determined in the context of the cargo's history of ambient temperatures. For instance, a cargo temperature of 32°C (90°F) during cold winter weather is cause for serious concern and investigation. The same temperature during hot summer weather may be quite normal. Temperatures reaching 45°C (113°F) should be cause for serious concern and immediate CHEMTREC notification regardless of ambient conditions. A 5°C (10°F) increase in temperature compared to the loading temperature should also be cause for serious concern and immediate CHEMTREC notification. **IF AT ANY TIME THE TEMPERATURE OF THE ACRYLATE REACHES 45°C (113°F) OR ABOVE, OR HAS A TEMPERATURE RISE OF 2°C (4°F) PER HOUR, IMMEDIATELY NOTIFY CHEMTREC AT 1-800-424-9300.** CHEMTREC will contact the supplier. High temperatures can be a warning sign or indicator of a possible inadvertent polymerization. High temperatures can cause an inadvertent polymerization and must be taken seriously. The truck should be isolated as dictated by the circumstances and conditions at the time. Also see Section 6 on instability and reactivity hazards and Section 11 on emergency response for more details.

### 9.4 TRUCKS

The use of tank trucks for bulk transport of acrylates is authorized by DOT. Authorized bulk containers are described in DOT regulations 49 CFR 173.242. Refer to this regulation for complete bulk packaging information, including special requirements.

DOT approved containers include the following:

- Tank Truck
  - Stainless steel or aluminum, coiled and insulated with DOT specification MC-304, MC-307, MC-310, MC-311, MC-312, MC-330, MC-331, DOT-406, DOT-407 or DOT-412.

DOT Hazardous Materials Regulations are contained in 49 CFR 100-180. Please consult these and local regulations for complete, up to date, tank truck specification packaging and placarding requirements.

See Table 9-1 for a summary of shipping and placarding information.

#### 9.4.1 Carrier information

The shipper is responsible for providing tank trucks that meet all guidelines for transport of acrylates, inhibition of the product, and proper product temperature for shipping. Temperature measurement of the product in transit is not mandated and is rarely done. However, **SHOULD AN INCIDENT OCCUR, SUCH AS AN ACCIDENT INVOLVING THE TANK TRUCK, AN ELEVATION IN TEMPERATURE OF THE TANK TRUCK CONTENTS, A STRONG ODOR IS NOTED, OR RESPONSIBLE PERSONNEL SUSPECT THE ACRYLATE IN THE TRUCK IS POLYMERIZING, IMMEDIATELY CONTACT CHEMTREC AT 1-800-424-9300.** CHEMTREC will contact the supplier.

## 9.4.2 Unloading

The following procedures are suggested to reduce risks during the unloading of acrylates. The contents of the truck must be positively identified before they are transferred. If sampling is required, refer to site-specific procedures. Continuous monitoring of the unloading process is appropriate.

An emergency shower and eye wash station should be directly accessible from and within 25 ft. (8 meters) of the unloading spot and other sources of water should be available for wash downs. The emergency shower and eye wash station should be tested periodically to ensure that they function properly. Personal protective equipment should be worn while sampling or making any connections.

Proper equipment should be used to protect against spills. The piping for unloading should be on continuous circulation or arranged so the acrylates will drain toward the storage tank when transfer is stopped. Where necessary, a check valve should be provided on the unloading hose to ensure that total tank contents will not spill in the event of a hose break. Pump glands, flanged fittings and valve stems should be provided with splash collars in cases where personnel could be exposed to major acrylate leaks or sprays.

### 9.4.2.1 Unloading Trucks with Closed Loop System

The recommended method for unloading a tank truck is by pumping with a closed loop (vapor return) system in which the displaced vapors are returned to the tank truck, or by sending the vapors to a scrubber or incinerator. The numbers in parenthesis below correspond to hoses, valves, lines, etc. in Figure 9-1 associated with the unloading procedure.

1. Spot the trailer and set wheel chocks. The engine should be stopped and the emergency breaks applied during unloading.
2. Connect tank truck grounding.
3. Check that the temperature of the cargo is consistent with previous receipts considering season of the year and is not higher than 45°C (113°F) before unloading. Normal temperature should be near ambient temperature. Verify that the receiving vessel will hold the entire contents of the tank truck.
4. Open top vapor (vent) valve (8).
5. Connect vapor hose and open valve (7) to equalize pressure and confirm that all vapor valves and lines are clear.
6. Connect liquid line (9) and open external (secondary) valve (10).
7. Open internal valve by using hydraulic pump and handle (11).
8. Start pump. Once flow has started, continue to monitor tank truck vapor return line and gauge to confirm flow and to avoid pulling a vacuum that may implode truck.
9. When the trailer is empty, shut off pump and close both internal and external liquid discharge valves (10 and 11).
10. Depressure liquid line, drain and disconnect hose (9), and replace cap.
11. Block in vapor system valves at (8) on tank truck and at ground level if equipped, remove hose, and replace caps.
12. Close and secure housings. Leave placards in place. Follow DOT guidelines for securing truck before shipment.
13. Disconnect ground and remove wheel chocks.
14. Verify that truck is empty. If truck cannot be emptied, notify shipper before returning the truck.

For additional information see the ICSHAM pamphlet, "Transportation of Acrylates by Tank Truck."

**Figure 9-1: Acrylates Tank Trucks**

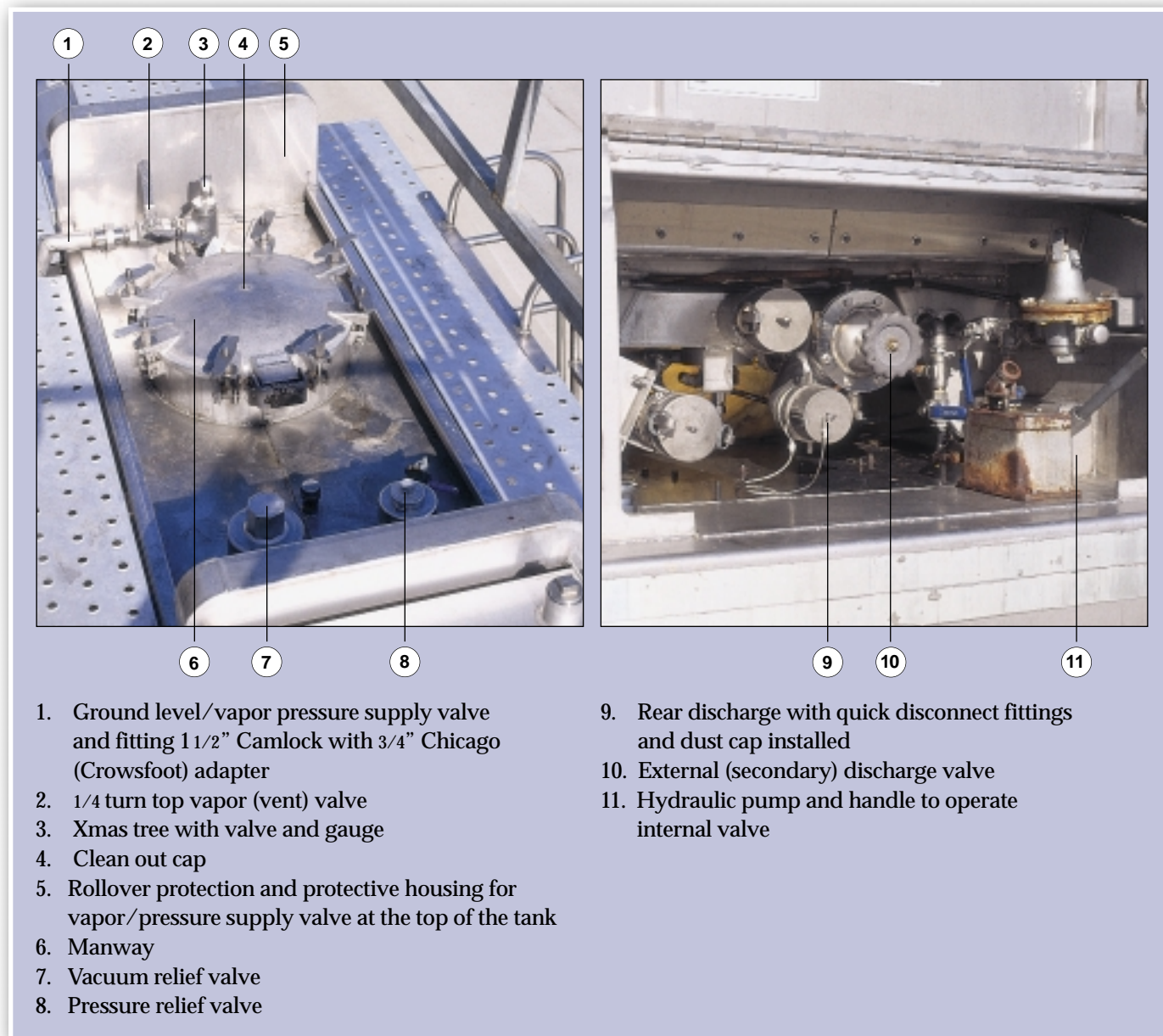

**9.4.2.2 Unloading Trucks With Pressure**

An alternate method for unloading is to pressure out the acrylate by using a gas containing 5 to 21 vol. percent of oxygen. The inhibitor, MEHQ, requires oxygen to prevent polymerization. DOT regulations restrict the use of air pressure with flammables. Please consult 49 CFR 172.24b(c) to ensure conformance with those restrictions. The pressure of the unloading gas should be regulated below 80 percent of the safety valve setting. The numbers in parenthesis below correspond to hoses, valves, lines, etc. in Figure 9-1 associated with the unloading procedure.

1. Spot trailer and set wheel chocks. The engine should be stopped and the emergency breaks applied during unloading.
2. Connect tank truck grounding.
3. Verify that the receiving vessel will hold the entire contents of the tank truck. Check that the temperature of the cargo is consistent with previous receipts considering season of the year and is not higher than 45°C (113°F) before unloading. Normal temperature should be near ambient temperature.
4. Open top vent valve (8).
5. Connect pressure supply hose and open vapor valve (7).
6. Open pressure supply hose valve enough to keep a positive pressure on the tank truck and confirm that all vent valves and lines are clear.

7. Regulate the unloading gas pressure so that it does not exceed 80 percent of the safety valve set pressure of the tank truck.
8. Connect liquid line (9) and open external (secondary) valve (10).
9. Open internal valve by using hydraulic pump and handle (11).
10. When the trailer is empty, quickly block in all valves to avoid overwhelming the tank's vent system.
11. Depressure liquid line, drain and disconnect hose (9), and replace cap.
12. Block in pressure supply system valve at ground level if equipped and/or on top (8), remove hose, and replace caps.
13. The receiving site may require that the truck be depressured. Vent the truck down to minimal pressure before returning it to the shipper. If the truck cannot be depressurized, add a tag stating "Truck under pressure".
14. Close and secure housings. Leave placards in place. Follow DOT guidelines for securing truck before shipment.
15. Disconnect ground and remove wheel chocks.
16. Verify that truck is empty. If truck cannot be emptied, notify shipper before returning the truck.

This procedure will work to pressure directly to storage tank as well as to pressure to a pump. For additional information see the ICSHAM pamphlet, "Transportation of Acrylates by Tank Truck."

## 9.5 RAIL CARS

The use of rail cars for bulk transport of acrylates is authorized by DOT. Authorized bulk containers are described in DOT regulations 49 CFR 173.242. Refer to this section for complete bulk packaging information, including special requirements.

DOT approved containers include the following:

- Rail Car

DOT Class 103, 104, 105, 109, 111, 112, 114, 115 or 120

Steel or stainless steel with stainless steel interior, unlined.

Aluminum, non-flammable with aluminum interior, unlined.

Aluminum, flammable with aluminum interior, unlined.

See Table 9-1 for a summary of shipping and placarding information.

Rail cars will typically have an eductor pipe and may have a gauging device and thermowell. DOT Hazardous Materials Regulations are contained in 49 CFR 100-180. Please consult these and local regulations for complete up to date rail car specification, packaging, and placarding requirements.

### 9.5.1 Carrier Information

The shipper is responsible for providing rail cars that meet all guidelines for transport of acrylates, inhibition of the product, and proper product temperature for shipping. Temperature measurement of the product in transit via rail is not mandated and is rarely done. However, **SHOULD AN INCIDENT OCCUR, SUCH AS AN ACCIDENT INVOLVING THE CAR, AN ELEVATION IN TEMPERATURE OF THE RAIL CAR CONTENTS, A STRONG ODOR IS NOTED, OR RESPONSIBLE PERSONNEL SUSPECT THE ACRYLATE IN THE CAR IS POLYMERIZING, IMMEDIATELY CONTACT CHEMTREC AT 1-800-424-9300.** CHEMTREC will contact the supplier. High temperatures and venting can be a warning sign or indicator of a possible inadvertent polymerization. High temperatures can cause an inadvertent polymerization and must be taken seriously. The car should be isolated as dictated by the circumstances and conditions at the time. Also see Section 6 on instability and reactivity hazards and Section 11 on emergency response for more details.

### 9.5.2 Unloading

The following procedures are suggested to reduce risks during the unloading of acrylates. The contents of the tank car should be positively identified before they are transferred. If sampling is required, refer to site-specific procedures. Continuous monitoring during unloading is appropriate.

An emergency shower and eye wash station should be directly accessible and within 25 ft. (8 meters) of the unloading spot, and other sources of water should be available for wash downs. The emergency shower and eye wash should be tested periodically to ensure that they function properly. Personal protective equipment should be worn while sampling or making any connections.

Proper equipment should be used to ensure against spills. The piping for unloading should be on continuous circulation or arranged so the acrylates will drain toward the storage tank when transfer is stopped. Where necessary, a check valve should be provided on the unloading hose to ensure that total tank contents will not spill in the event of a hose break. Pump glands, flanged fittings and valve stems should be provided with splash collars in cases where personnel could be exposed to major acrylate leaks or sprays.

### **9.5.2.1 Unloading Rail Cars with Closed Loop System**

The recommended method for unloading a tank car is by pumping with a closed loop (vapor return) system in which the displaced vapors are returned to the tank car, or by sending the vapors to a scrubber or vapor incinerator. If the tank car is used to collect the vapors, the shipper must be notified that the tank car contains product vapors under pressure. Please refer to the ICSHAM pamphlet "Transportation of Acrylates by Rail Car" for additional information.

1. Ensure that the hand brake is set, the wheels are chocked, and "tank car connected" sign is in place on the track. Derailers should be in place or switches locked out.
2. Connect the ground cable to the tank car.
3. Verify that the receiving vessel will hold the entire contents of the rail car.
4. On the top of the tank car, remove the seal pin on the eduction equipment cover and open cover. If temperature indication is available, check that the temperature of the cargo is consistent with previous receipts considering season of the year and is not higher than 45°C (113°F) before unloading. Normal temperature should be near ambient temperature.
5. Examine all valves to be certain that they are closed before removing caps, plugs, or flanges.
6. Connect vapor hose to vent valve on tank car and open valves to equalize pressure and confirm all vapor valves and lines are clear.
7. Connect unloading line to the eduction valve, or if unloading from the bottom, the bottom outlet valve.
8. Close all bleeds on the unloading line and open the eduction valve, or if bottom unloading, open the bottom outlet secondary valve, then open the bottom outlet valve.
9. Start pump. Once flow has started, continue to monitor tank car vapor return line and gauge to confirm flow to avoid imploding the tank car.
10. When the tank car is empty, shut off pump and close all liquid discharge valves.
11. Depressure unloading line, drain and disconnect the hose and fittings.
12. Block in vapor system valve and vent valve on the tank car. Depressure and disconnect hose.
13. Re-install all flanges and plugs removed. Close and secure all housings. Follow DOT guidelines for securing rail car before shipment.
14. Per DOT regulations at the time of this publication, placards are NOT to be reversed.
15. Disconnect electrical ground and remove wheel chocks. Remove "tank car connected" sign, remove derailleurs, and unlock switches.
16. Verify that tank car is empty. If tank car cannot be emptied, notify shipper before returning the tank car.

### **9.5.2.2 Unloading Rail Cars with Pressure**

An alternate method for unloading is to pressure out the acrylate by using a gas containing 5 to 21 vol. percent of oxygen. The inhibitor, MEHQ, requires oxygen to prevent polymerization. DOT regulations restrict the use of air pressure with flammables. Please consult 49 CFR 172.24b(c) to ensure conformance with those restrictions. The pressure of the unloading gas should be regulated below 80 percent of the safety valve setting. This procedure will work to pressure directly to a storage tank as well as to pressure to a pump. If the tank car is used to collect the vapors, the shipper must be notified that the tank car contains product vapors under pressure. Please refer to the ICSHAM pamphlet "Transportation of Acrylates by Rail Car" for additional information.

1. Ensure that the hand brake is set, the wheels are chocked, and "tank car connected" sign is in place on the track. Derailers should be in place or switches locked out.
2. Connect the ground cable to the tank car.
3. Verify that the receiving vessel will hold the entire contents of the rail car.
4. On the top of the tank car, remove the seal pin on the eduction equipment cover and open cover. If temperature indication is available, check that the temperature of the cargo is consistent with previous receipts considering season of the year and is not higher than 45°C (113°F) before unloading. Normal temperature should be near ambient temperature.
5. Examine all valves to be certain that they are closed before removing caps, plugs, or flanges.
6. Connect pressure supply hose to the vent valve on the tank car, and open the vent valve.
7. Connect unloading line to the eduction valve, or if bottom unloading, connect to the bottom outlet.
8. Close all bleed valves on the unloading line, and open tank car valve or valves connected to the unloading line.
9. Open pressure supply hose valve enough to keep a positive pressure on the tank car.  
Regulate the unloading gas pressure so that it does not exceed 80 percent of the safety valve set pressure stenciled on the side of the tank car.
10. Open unloading line valve.
11. When the tank car is empty, block in pressure supply hose valve, tank car unloading valve, and unloading line valve. This needs to be done quickly to avoid overwhelming the tank's vent system.

12. Depressure unloading line, disconnect and remove the unloading line and fittings from the tank car.
13. Vent the tank car down to minimal pressure before returning it to the shipper. If tank car cannot be depressured, add a tag stating "tank car under pressure".
14. Block in vent valve on tank car. Depressure and disconnect pressure supply hose from the car.
15. Re-install all flanges and plugs removed. Close and secure all housings. Follow DOT guidelines for securing rail car before shipment.
16. Per DOT regulations at the time of this publication, placards are NOT to be reversed.
17. Disconnect ground and remove wheel chocks. Remove "tank car connected" sign, remove derails and unlock switches.
18. Verify that tank car is empty. If tank car cannot be emptied, notify shipper before returning the tank car.

## 9.6 DRUMS AND INTERMEDIATE BULK CONTAINERS (TOTES)

The use of drums or IBCs (totes) for transport of acrylates is authorized by DOT. Non-bulk performance oriented packaging standards in DOT 49 CFR 178.500 require testing of non-bulk acrylates shipping containers for Hazard Class, Packing Group, and subsidiary Hazard Class as shown in Table 9-1. Your container supplier can perform testing and guarantee conformance to DOT requirements.

Containers that may test acceptably to DOT requirements for acrylates include the following:

- 55 - Gallon
  - UN 1A1, steel drum or steel drum with phenolic internal coating
  - UN 1H1, self-supporting high-density polyethylene drum.

Authorized bulk containers are described in DOT regulations 49 CFR 173.242. Refer to this section for complete, up to date bulk packaging information, including special requirements.

DOT approved containers include the following:

- IBC
  - UN 31A, 31B, 31N or 31HA1

Please consult DOT Hazardous Materials Regulations as contained in 49 CFR 100-180 and local regulations for complete, up to date specifications on packaging and placarding/labeling requirements.

Containers of acrylates should be labeled properly. Before transporting, storing or handling acrylates, the current product and labeling information and the MSDS (available from your supplier) should be obtained, read and understood. Appropriate wording should be used on the label in addition to specific wording required by law.

Place the identifying label on each package. Stencil the generic name on the package. Proper DOT shipping information is summarized in Table 9-1.

Prevention of contamination can be difficult with IBCs (totes). If mishandled, IBCs (totes) containing acrylates have significantly worse consequences than drums because of the increased size. For these reasons, extra care should be taken in the proper handling and transportation of IBCs (totes) containing acrylates.

### 9.6.1 Carrier Information

Avoid sources of heat, sparks, or flame. Shipment at ambient conditions is acceptable. Do not load or transport bulging or distorted drums. Bulging drums may indicate polymerization. **IF POLYMERIZATION IS SUSPECTED, IMMEDIATELY NOTIFY CHEMTREC AT 1-800-424-9300.** CHEMTREC will contact the supplier. See also Section 6, Instability and Reactivity Hazards and Section 11, Emergency Response for more details.

### 9.6.2 Storage of Drums and Intermediate Bulk Containers (Totes)

Acrylates are normally inhibited with 10 to 20 ppm of MEHQ to prevent polymerization.

The three most important considerations in shipping, storing and handling acrylates are to **AVOID EXPOSURE TO ELEVATED TEMPERATURES, AVOID CONTAMINATION AND USE AN OXYGEN CONTAINING BLANKET GAS.**

- Do not store acrylate containers in direct sunlight.
- Contamination can cause an uncontrolled polymerization which may result in violent rupture of the container, fire, serious damage to the surroundings and significant environmental impact.
- The presence of oxygen is required for the inhibitor (MEHQ) to be effective. Lack of oxygen can cause an uncontrolled polymerization.
- Reuse drums or IBCs (totes) only if thoroughly cleaned or in dedicated service.
- Drums or IBCs (totes) should be inspected periodically. Follow your supplier's shelf life recommendations (typically 1 year).

### 9.6.3 Handling Procedures

Methyl, ethyl and butyl acrylates are flammable liquids and should be handled accordingly. The contents of the drums and IBCs (totes) should be positively identified before they are transferred. The procedures outlined below are suggested to reduce risks during the handling of acrylates.

#### 9.6.3.1 Receipt of Drums and Intermediate Bulk Containers (Totes)

Acrylates are shipped in steel drums and stainless steel or high density polyethylene IBCs (totes). When a carload or truckload of drums or IBCs (totes) is received, leave the doors of the car or truck open for ventilation before entering. A persistent strong odor may indicate a leaky container.

#### 9.6.3.2 Emptying Drums and Intermediate Bulk Containers (Totes)

The following steps outline procedures for safely emptying drums and IBCs (totes). Refer to the ICSHAM pamphlet “Transportation of Acrylates in Drums” for more information.

1. Drums and IBCs (totes) must be electrically grounded during transfer operations and a static-free dip pipe or flexible steel hose used to drain the acrylates.
2. Drums, IBCs (totes) and fittings should never be struck with tools or other hard objects which may cause sparking.
3. Before removing plugs from acrylate drums or IBCs (totes), locate the nearest emergency safety shower and eye wash station and put on personal protective equipment.
4. The preferred safe method for emptying drums and IBCs (totes) is by pumping. If drums or IBCs (totes) are emptied by gravity, the valves should be self-closing. Do not use pressure to displace drum or IBC (tote) contents.
5. Provide adequate vacuum breaking to prevent collapse of the drums or IBCs (totes) during emptying.

**Table 9-1: Summary of Shipping and Placarding Acrylates**

Shipping Information	Methyl Acrylate	Ethyl Acrylate	n-Butyl Acrylate	2-Ethylhexyl Acrylate
DOT Classification	Flammable Liquid	Flammable Liquid	Flammable Liquid	Combustible Liquid
Shipping Name	Methyl Acrylate, stabilized	Ethyl Acrylate, stabilized	Butyl Acrylate, stabilized	Combustible Liquid, n.o.s. (2-Ethylhexyl Acrylate)
DOT Labels	Flammable Liquid	Flammable Liquid Corrosive	Flammable Liquid	None Required
DOT Placard	Flammable	Flammable	Flammable	Combustible
DOT I.D. Number	UN1919	UN1917	UN2348	NA1993 Bulk Only
Freight Class	Methyl Acrylate	Ethyl Acrylate	n-Butyl Acrylate	2-Ethylhexyl Acrylate
Hazard Class	3	3	3	Combustible Liquid
Packing Group	II	II	III	III
Subsidiary Hazard Class	-	8	-	-
DOT Emergency Response Guide No.	129P	129P	129P	128P



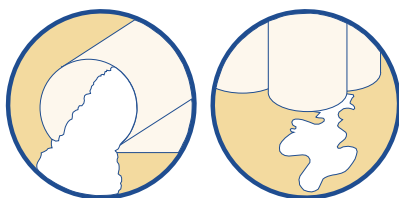

## 10 ENVIRONMENTAL CONSIDERATIONS FOR ACRYLATES

---

### 10.1 ENVIRONMENTAL FATE

Because of their reactivity, acrylates are generally not persistent in the environment. They disperse via a combination of mechanisms, including biodegradation, oxidation, and volatilization.

#### 10.1.1 Biodegradation

In biochemical oxygen demand (BOD) studies, methyl acrylate showed limited biodegradability, while ethyl and butyl acrylates were easily degraded in water inoculated with sewage bacteria. Acrylates are also amenable to anaerobic treatment, degrading to about 60 percent of theoretical methane in acclimated cultures.

Acrylates are low to moderately toxic to fish, aquatic invertebrates and algae, but not persistent in aquatic environments, due to rapid oxidation. Large releases can deplete dissolved oxygen<sup>18</sup>.

#### 10.1.2 Volatilization / Soil Adsorption

The mobility of acrylic esters in soil is classified as medium to very high. Compounds with medium mobility may accumulate to some degree in sediments, but undergo significant biodegradation and volatilization, while those of high mobility would pass through soil quickly and not accumulate in sediments.

### 10.2 DISCHARGES

#### 10.2.1 General Information

A variety of federal, state and local regulations govern the release of any material to the land, air or surface waters. Any release or discharge of acrylates must be evaluated in the context of these regulations to determine appropriate response actions and reporting requirements.

A regulation called Resource Conservation and Recovery Act (RCRA) must be followed if a volume of acrylates or material contaminated with acrylates is to be disposed of or discarded. Based on RCRA criteria, acrylates or materials contaminated with acrylates will likely be considered a 'Hazardous Waste' upon disposal and must follow certain storage, handling and disposal restrictions as outlined in RCRA. Strict adherence to these restrictions as well as proper characterization and labeling of the material is the responsibility of the generator and handler of the waste material.

Many industries are subject to the Toxic Release Inventory requirements under EPA's SARA 313 (Emergency Planning and Community Right-To-Know) regulations. Releases of acrylates to all environmental media must be reported annually.

Acrylates are also subject to the Hazardous Substance Inventory and hazard classification requirement of EPA's SARA 311 and 312 programs. Acrylates meet the following characteristic categories for these programs: fire, reactive, acute health, and chronic health.

#### 10.2.2 Discharges to Navigable Waters

Discharges to streams and other navigable waters are controlled under federal and state regulations, including a National Pollutant Discharge Elimination System (NPDES). Both point-source (pipe and treatment point) and non-point-source (storm water) discharges may require permitting and will be required to meet site-specific effluent limitations. Non-compliance with these limitations or discharge without an effluent permit is subject to significant civil and criminal penalties.

#### 10.2.3 Discharges to Municipal Sewers

Discharges to public sewers and treatment works are regulated by federal, state and local regulations (including effluent limitations and any pre-treatment requirements), and by the specific permit conditions for the receiving treatment works. No acrylates should be discharged to a municipal sewer without the prior agreement of the operator of the treatment works.

## 10.2.4 Emissions to Air

Atmospheric emissions of acrylate monomers are subject to federal, state and local regulations. State or state-designated local authorities control sources of volatile organic compounds such as acrylate monomers in order to achieve and maintain the national ambient air quality standard for ozone. Ozone in the atmosphere is a result of volatile organic compounds reacting with nitrogen oxides in the presence of sunlight.

Regulatory authorities require stringent controls for acrylate emissions because these monomers have very low odor thresholds and can cause discomfort at low ambient air concentrations. Some regulations require vapor recovery or other emission abatement systems for bulk loading/unloading of volatile organic compounds. They may also require a fugitive emission monitoring program which involves inspection and maintenance of valves, pumps and compressors associated with the transfer of volatile organic compounds.

All applicable governmental regulations to control air pollution should be reviewed to ensure compliance. The air pollution control division of most state environmental agencies is able to provide guidance on standards which must be met and any permits or other operating authority which may be needed.

Buildings used for processing or storage must be well ventilated to prevent local accumulation of vapors and their toxic effects upon personnel. Ventilation methods include local exhaust and general dilution procedures. Local exhaust is most effective where vapors are emitted from local sources, such as liquid transfer points, pump houses and reactor areas. The method may involve operation within an exhaust hood or removal of vapors through ducts connected to an exhaust fan (see Section 6.2 for specifications of electrical equipment). General dilution ventilation may be used when vapors are emitted from scattered points throughout a storage or processing area. In this method, vapors are diluted and expelled by changing the air within the room or building. The ACGIH offers a publication entitled "Industrial Ventilation: A Manual of Recommended Practice". This manual should be consulted for information on the design of exhaust hoods and ventilating equipment and recommended dilution air change rates. Whichever ventilation procedure is adopted, the level of vapors can be held to a minimum by keeping equipment in good tight repair and by confining all volatile materials. The ventilated air may require odor abatement.

### 10.2.4.1 Removal of Acrylate Vapors from Contaminated Air

Vapors of acrylate monomer can be removed from air by scrubbing with a caustic and/or an amine solution, combustion, adsorption on activated carbon, venting to a flare, incineration or a combination of these methods (see Section 7.1.1.)

- Scrubbing with a Caustic Solution

Air streams contaminated with acrylate vapors can be purified by absorbing the vapors in aqueous sodium hydroxide and/or amine solution. Additional information and advice is available from your supplier. Note that disposal of the spent scrubbing solution is regulated by federal, state and local authorities.

- Incineration

Acrylate vapors in exhaust air can be burned using flare stacks, thermal incinerators or catalytic incinerators. The choice of equipment is dependent upon the properties of the stream being treated as well as local permits and environmental regulations. Consult the suppliers of the combustion equipment for design assistance.

- Absorption on Activated Carbon

Canisters of activated carbon can be used **BUT ONLY AFTER A SCRUBBING SYSTEM AS A BACK-UP OR FINISHING BED**. During the adsorption process, oxidation and evolution of heat may occur, which can raise the temperature of the adsorbent. At high acrylate concentrations, local overheating may ignite the system. For this reason, a flame arrester should be installed between the storage tank and adsorption canisters. The activated carbon may be regenerated or disposed of after use. The disposal of the spent adsorbent is regulated by federal, state, and local authorities.

## 10.2.5 Releases to Land

Treatment and disposal of acrylates and mixtures containing acrylates are subject to federal regulations and state delegation of such regulation. Acrylates or mixtures of acrylates cannot be disposed of on the land without a permit and without prior treatment to specific standards (see Section 10.4).

## **10.3 SPILL AND LEAK CONTROL**

### **10.3.1 General Information**

Emphasis should be placed on the prevention of releases through careful design of equipment and sound operating procedures. If acrylates are lost from containment through a leak or spill, care should be taken to use the proper personal protective equipment (see Section 5.5) decontamination procedures, and other safety measures.

It is important to remember that spills of acrylates and materials contaminated by acrylates may need to be handled as RCRA hazardous wastes.

Any release of acrylates greater than the “reportable quantity” designated by the EPA in CERCLA or SARA should be reported immediately on discovery to the National Response Center and State Emergency Response Agency (see current MSDS for reportable quantity and pertinent phone numbers).

### **10.3.2 Small Spills (Up To 4 Liters)**

Use proper personal protective equipment (see Section 5.5). Commercially available spill cleanup kits may be used. If biological wastewater treatment is available, or the wastewater treatment system is capable of handling the material, the spill may be sparingly diluted with water and allowed to enter the treatment system. Otherwise, use a suitable adsorbent to pick up the spill. Dispose of the contaminated adsorbent, any contaminated soil, and any supplies or personal protective equipment which cannot be decontaminated as RCRA hazardous waste.

### **10.3.3 Large Spills (Greater Than 4 Liters)**

Use proper personal protective equipment (see Section 5.5). If possible, contain the spill within a diked area and proceed to recover the material in appropriate containers. Every effort must be made to keep the material out of sewers (danger of explosion) and surface waters.

In the event of accidental spillage of acrylate monomers to surface waters or to a municipal sewer system, the appropriate pollution control and water supply agencies must be notified. Floating booms are available for confining floating liquids and should be kept on hand where the possibility of spillage to surface waters exist. With their use, the floating monomer can be pulled into a smaller area and skimmed off for recovery or disposal. Absorbing pads and other absorbents are useful for spills on the ground or surface waters and should also be kept on hand.

If contaminated dirt is classified as hazardous waste, under Federal Resource Conservation and Recovery Act (RCRA) land ban rules, it must be incinerated in a rotary kiln type incinerator.

## **10.4. DISPOSAL OF WASTES**

All of the acrylates must, if discarded, be disposed of by a permitted waste facility. These materials cannot be disposed of directly in a hazardous waste landfill. A preferred disposal route is incineration or burning for heat recovery in equipment which has had inspection/approval by the appropriate federal or state agency. Polymer may be disposed of in a permitted landfill or incinerated.

The destruction of aqueous waste streams containing dissolved monomers by a biological digestion system which is part of a plant waste disposal system is a very satisfactory method. When such a system is properly operated, the danger of later contamination of public water supplies is eliminated. Trickle filters are not recommended for disposal of these monomer wastes.

Though adequate dilution of concentrated wastes can reduce odor problems and fire hazard, direct disposal of dilute wastes to municipal sewage may still result in the pollution of drinking water. Acrylate monomers impart a pronounced taste which may be detected at levels as low as 0.1 ppm. If poorly treated municipal sewage is discharged to a river or lake, a taste may thus develop in the water. The final disposition of treated sewage and the method of treatment must therefore be considered carefully before concluding that wastes may be safely added to public sewers.

See your supplier MSDS for RCRA classification and reportable quantities.

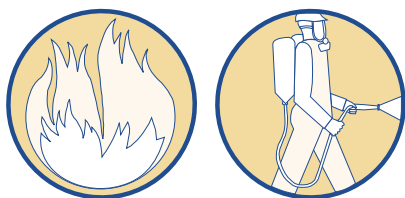

## 11 EMERGENCY RESPONSE

---

Signs of an emergency involving acrylates often involve increased temperatures (due to external heating or a polymerization exotherm), and venting or bulging of the container. **THE PROPER INITIAL ACTION IF THERE IS AN EMERGENCY DURING TRANSPORT OR IN A USER'S TANK OR DRUMS IS TO CALL CHEMTREC AT 800-424-9300.** CHEMTREC will notify the supplier and facilitate the establishment of communications between the personnel at the emergency site and the supplier's emergency response team.

Users of acrylates should develop written emergency plans for acrylate spills, fires, exotherms and incipient polymerizations. These plans should focus on clearly identifying the features that categorize an event as an emergency, what should be done to secure the emergency site and immediate actions to mitigate the danger. A very important feature of the plan should be early notification of CHEMTREC of the incident so that the supplier can quickly provide expertise in helping to manage the incident.

### 11.1 DETECTION AND RESPONSE TO INCIPIENT POLYMERIZATION IN A STORAGE TANK

If a system is installed and operated with all of the prevention measures recommended in this brochure and required by prudent engineering practice, the chances of experiencing an inadvertent polymerization are minimized. However, in case of unforeseen events which might lead to incipient polymerization in a storage tank, it is necessary to detect such an event in a timely manner to avoid, stop or mitigate polymerization. An option to provide additional protection from these unforeseen events is the use of a restabilization (shortstop) system. Safety analysis should be used in deciding whether or not this or other options are appropriate for your site. This subsection deals with the design and operation of such an optional restabilization system. We hope this is helpful if your safety analysis indicates this is an appropriate choice.

#### 11.1.1 Initiation Scenarios

Possible causes of acrylate runaway polymerizations are external overheating, removal of the dissolved oxygen from the monomer and chemical contamination. If the monomer is purged with an inert (oxygen-free) gas (e.g., nitrogen or fuel gas) and the dissolved oxygen is removed, the MEHQ inhibitor becomes ineffective and polymerization will ultimately occur. The length of the induction period until polymerization occurs and the maximum rate of polymerization are unpredictable because they depend on the previous storage history of the acrylate. If inert gas purging is known to have occurred, the acrylate should be sparged with a gas containing 5 to 21 vol. percent of oxygen as soon as possible. Air is preferred.

The scope of a contamination scenario is very difficult to pre-define since the identity and concentration of the contaminant are unpredictable. However, it is recommended that the restabilization (shortstop) system be immediately activated if contamination with a known or potential polymerization initiator has taken place. If such contamination has occurred without the knowledge of responsible personnel, the restabilization (shortstop) system should ultimately be activated in the event of a polymerization exotherm.

#### 11.1.2 Polymerization Detection

The most reliable way to detect the approach to a runaway polymerization is by redundant temperature monitoring of the tank contents. The actual temperature is compared to the "normal" storage temperature range. Acrylates are usually stored at ambient temperatures in tanks that do not have any special provisions for temperature control. Consequently, it is difficult to define the normal temperature range for stored acrylates. An abnormally high temperature is an important indicator of polymerizing tank contents. What is "abnormal" must be determined in the context of the tank's temperature history. For instance, a product temperature of 90°F during cold winter weather is a warning sign of polymerization. The same temperature during hot summer weather or right after a transfer of warm acrylate into the tank might be quite normal. Thus, judgement must be used in deciding whether a safety problem exists or not.

**TEMPERATURES OF 40°C (104°F) OR HIGHER MAY INDICATE A HAZARDOUS SITUATION AND SHOULD BE IMMEDIATELY INVESTIGATED.**

**IF AT ANY TIME THE TEMPERATURE OF THE ACRYLATE REACHES 45°C (113°F) OR ABOVE, OR HAS A RISE OF 2°C (4°F) PER HOUR, IMMEDIATELY NOTIFY CHEMTREC AT 1-800-424-9300.**

An experienced chemical analyst may aid in the investigation by carrying out a soluble polymer test.

### **11.1.3 Restabilization (Shortstopping – An Optional Safety Enhancement)**

Successful restabilization of acrylates requires a timely response to detection of a significant temperature increase. The lack of a timely response may result in the onset of polymerization leading to accelerated temperature and pressure rises. Due to the large number of possible contaminants and concentrations of those contaminants, shortstopping may not be successful if the cause of the polymerization is contamination.

#### **11.1.3.1 Restabilization (Shortstop) Inhibitor**

Experimental evidence leads to the recommendation of phenothiazine (PTZ) as the preferred shortstop agent. Any other materials (including MEHQ) used in this service may be ineffective or even detrimental. Phenothiazine is a solid, and for ease of mixing and addition, it should be added as a solution. While addition of PTZ has worked in most cases, there is no assurance that it will be effective in every case. Obvious exceptions are contamination of acrylates with gross amounts of a polymerization initiator or a delay in activation of the shortstop system.

Addition of a large amount of water to acrylates undergoing polymerization is not recommended. Although this will theoretically moderate the reaction by removing heat, the release of large volumes of steam and acrylate vapor, and the possibility of tank overflow seriously detract from the efficacy of this option<sup>19</sup>.

#### **11.1.3.2 Restabilization (Shortstop) Inhibitor Solvent**

The following criteria are recommended for the selection of a solvent for the PTZ shortstop inhibitor:

- It should be a good solvent for PTZ (preferably at least 6 wt percent PTZ solubility at the lowest anticipated ambient temperature) and be miscible with acrylate monomers.
- It should not be viscous.
- It should not promote polymerization and should be inert to the system.
- It should not be highly toxic.
- It should not exacerbate any potential fugitive emission problem resulting from the emergency.
- (Optional) If successfully shortstopped, the acrylate containing the solvent should be capable of being repurified.

Examples of solvents used for shortstop PTZ are ethyl acetate, isopropyl acetate, N-methylpyrrolidone and tripropylene glycol. Contact your supplier for solvent recommendations.

The PTZ shortstop solution should be as highly concentrated as possible to minimize its volume so that it can be pumped into the system in as short a time as possible. The final desired concentration of PTZ in the acrylate to be shortstopped is typically in the range of 200 to 1,000 ppm. However, in the case of contamination, restabilization may not be possible at ANY concentration of PTZ, depending on the nature and concentration of the contaminant.

#### **11.1.3.3 Activation Criteria for Restabilization (Shortstop) Systems**

It is recommended that the restabilization (shortstop) system be immediately activated if any of the following criteria is satisfied:

- A temperature rise of greater than 10°C (18°F) has been detected in one hour or less without external cause.
- The temperature in the liquid has reached 50°C (122°F).
- There is a fire near an acrylates tank.
- A known polymerization initiator has been inadvertently added to the acrylates.

These criteria have been chosen to ensure adequate time for the restabilizing agent to be fed to and dispersed in the tank contents. Lower temperatures or temperature rises than stated above may indicate an on-going polymerization. Any temperature or temperature rise that exceeds the possible rise from external heat sources (ambient, sun, pumps, temperature control systems, receipt of warmer product, etc.), may indicate an exotherm from on-going polymerization. The lowest practical temperature or temperature rise should be used as a call for investigation. Manual activation of the shortstop system is preferred for sites with continuous manning; otherwise automatic activation of the shortstop system should be used. In either case, the shortstop system should be activated if the criteria specified above are met.

**UNDER NO CIRCUMSTANCES SHOULD ANYONE APPROACH A TANK WHOSE CONTENTS HAVE REACHED 50°C (122°F).**

#### 11.1.3.4 *Mixing of Restabilization (Shortstop) Inhibitor*

It is possible to quickly bring the concentration of the shortstop inhibitor to effective levels by circulating the tank contents with a pump<sup>20</sup> and/or by injecting a gas. If a pump is used to mix shortstop solution, its shutdown instrumentation must be designed to accommodate the emergency procedure. The use of eductor tubes on the tank inlet(s) or a gas lift can reduce the time required to mix the shortstop solution with the tank contents.

An important factor in the design and installation of the shortstop inhibitor system is the specific tank farm layout. The number of acrylate tanks, the location of diked walls and the types of chemicals within the diked areas should all be considered when planning a shortstop storage and distribution system. The shortstop system should be capable of distributing adequate inhibitor to all the acrylate tanks which could be involved in a given incident. For multiple tank protection, the options include a single inhibitor tank with controlled metering, separate dedicated inhibitor tanks and mobile inhibitor tanks. Your supplier can provide further details.

Another consideration is the location of the inhibitor tank(s) and how their contents will be delivered to the storage tanks. If the tanks are at ground level and at some distance from the acrylates storage tanks, ancillary pump(s) may be necessary to transfer the PTZ solution from the inhibitor tank to the storage tanks. Alternatively, the inhibitor tank(s) may be located in elevated positions near the storage tanks, with the inhibitor solution being pressured into or flowing by gravity into the storage tanks' recirculation lines. These options are best examined by plant personnel who are most familiar with the specific tank farm layout.

#### 11.1.3.5 *Examples of Restabilization (Shortstop) Systems*

A shortstop inhibitor system is an emergency response system for runaway polymerization mitigation in acrylate storage tanks. It is an optional safety enhancement. Shortstop inhibitor systems can vary in complexity and cost. The design of any such system must be based on a careful risk analysis by the user. Your acrylate supplier can provide further information. Figures 11-1 and 11-2 represent two examples of shortstop systems. The key to symbols in Figures 11-1 and 11-2 is found in Table 7-2.

In Figure 11-1, the inhibitor solution is 6 wt percent phenothiazine (PTZ) dissolved in ethyl acetate solvent. The shortstop tank (V-2) protects acrylate storage tank (V-1). The tie-in of the shortstop inhibitor system with the acrylate tank system is at the exit of the recirculation pump. Rapid mixing of the shortstop inhibitor solution with the acrylates in the storage tank is achieved by eductor tubes inside the acrylate tank. The eductor tubes are located at the discharge of the acrylate tank pump circulation loop.

The delivery of shortstop inhibitor solution to the acrylate tank is based on the blowcase operation concept. The inhibitor solution is pressurized into the tank by nitrogen, air or an air/nitrogen mixture. In this example, nitrogen is chosen as the primary gas supply source. The air/nitrogen mixture is used as a back-up source if the nitrogen system fails. The acceptability of nitrogen in this service is based on the fact that **PTZ DOES NOT REQUIRE THAT ACRYLATES HAVE DISSOLVED OXYGEN IN ORDER TO BE AN EFFECTIVE INHIBITOR.**

After charging the shortstop inhibitor solution to the inhibitor tank, the inhibitor tank is pressurized to a suitable supply pressure. When the shortstop inhibitor system is not in service, the inhibitor tank pressure may vary as inert gas supply pressure valves leak or ambient temperature changes. Pressure changes in the tank may result in a loss of ethyl acetate by evaporation, which will increase the PTZ concentration. A PTZ concentration change from 6 percent to 7 percent will cause a PTZ crystallization point rise from about -18°C to -9°C (0°F to 16°F). Therefore, when the shortstop inhibitor system is not in service, both the inert gas supply lines and the inhibitor solution tank should be isolated to minimize solvent loss.

The PTZ concentration in the shortstop solution should be checked periodically (by gas or high performance liquid chromatography [GC or HPLC], and NOT by a colorimetric method). The lower part of the inhibitor tank piping should also be checked for solid sediment (PTZ decomposition products), which might block the lines.

In Figure 11-2, the inhibitor solution is 50 wt percent PTZ dissolved in N-methylpyrrolidone<sup>21</sup>. The shortstop tank and compressed gas cylinder can be a mobile or a fixed unit. The tie-in is made so that inhibitor solution and subsequent gas can be injected into the bottom section of the acrylates tank. The general steps for restabilizing an acrylates tank using the system illustrated in Figure 11-2 are as follows:

- Connect the shortstop tank to the delivery system with dry disconnect fittings.
- Open the appropriate automatic and/or manual valves to pressure the inhibitor solution into the acrylate tank using air or nitrogen (air is used in this example).
- After the shortstop tank is empty of inhibitor solution, the air will flow through the submerged nozzle at a moderate rate, mixing the contents by the gas lift principle. The air flow rate is limited by an orifice located between the air cylinder and the pressure regulator.

Contact your supplier for further information on shortstop systems.

**Figure 11-1: Acrylates Shortstop System Example I**

This example illustrates some safety features discussed in this booklet. Not all equipment or instrumentation required for operability is shown. See Table 7-2 for key to symbols.

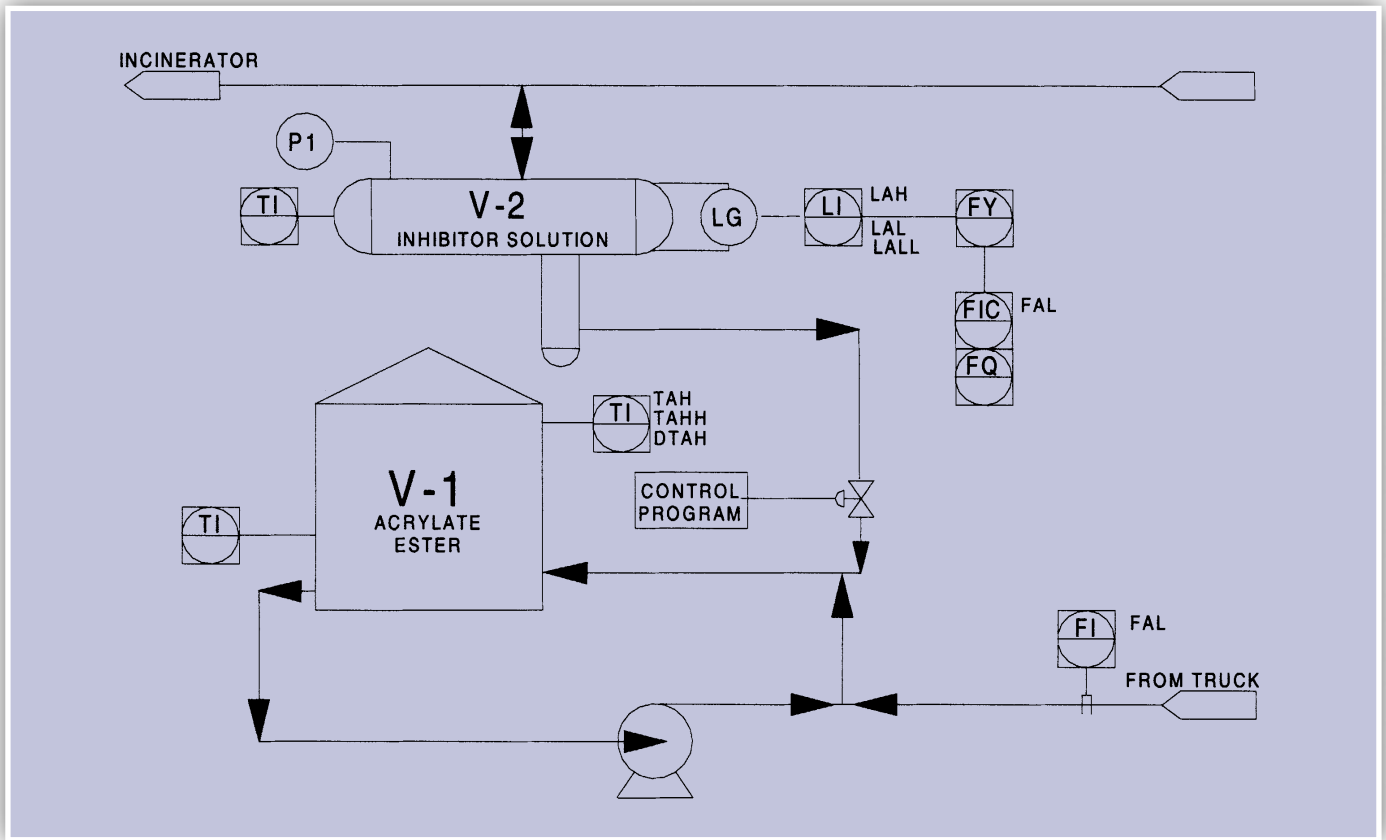

**Figure 11-2: Acrylates Shortstop System Example II**

This example illustrates some of the safety features discussed in this booklet. Not all equipment or instrumentation required for operability is shown. See Table 7-2 for key to symbols.

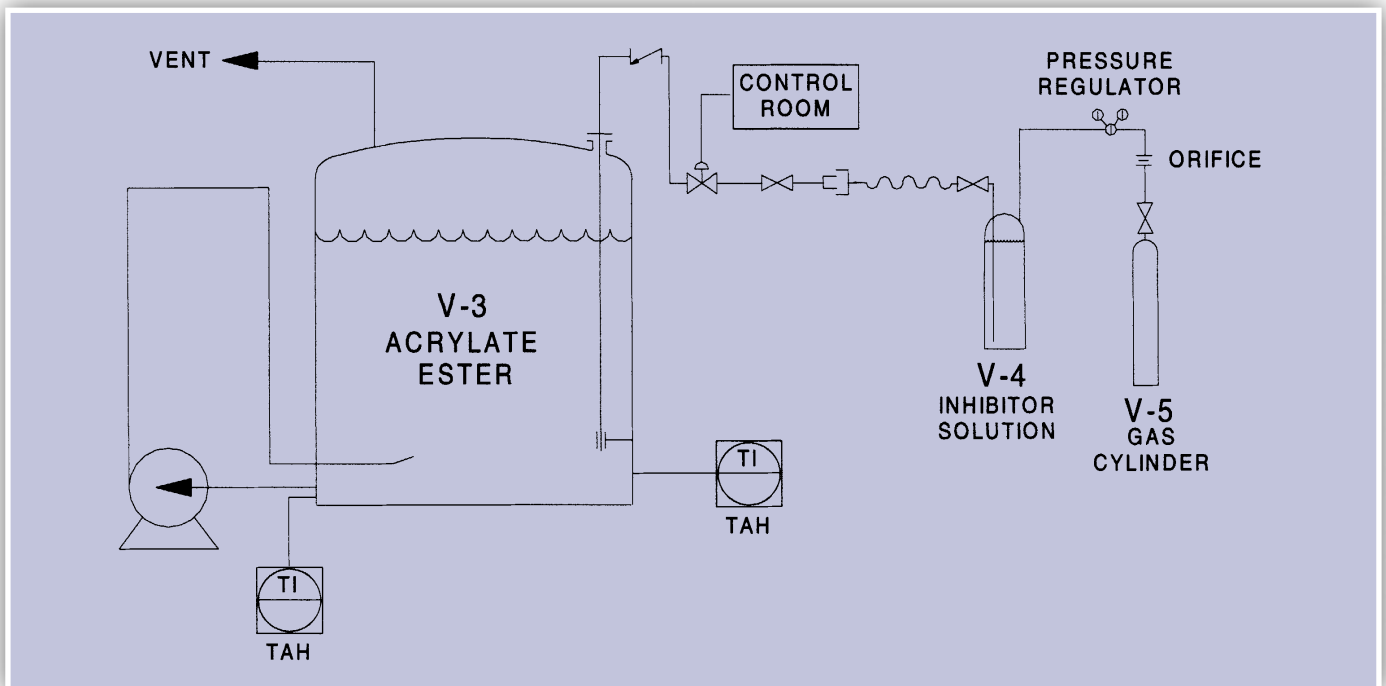

## 11.2 Spills

Containment is the most important technique for handling spills. Numerous techniques have been used successfully in containing spills: for material on the ground, diking, diverting and absorption; for material still in the leaking container, plugging, patching, repairing, tightening of container fittings or secondary containment (drums). More information on spills is given in Section 10.3.

## 11.3 Fires

Methyl and ethyl acrylates readily form and n-butyl acrylate may form flammable mixtures with air at ambient temperatures. They must be protected from all potential sources of ignition. Methyl and ethyl acrylates have flash points below 37°C (100°F) and are, therefore, classified as “FLAMMABLE” liquids by the NFPA. The flash points of n-butyl and 2-ethylhexyl acrylates are above 100°F but below 200°F, and they are classified as combustible liquids by NFPA. However, butyl acrylate is classified as a “FLAMMABLE LIQUID” by DOT. Under fire conditions, rapid and uncontrolled polymerization can occur, resulting in an explosion. Vapors are heavier than air and may travel considerable distances to an ignition source and then flash back.

Acrylates are reactive materials which can polymerize if exposed to high temperatures. Therefore it is critical that any emergency plan contain measures to closely monitor the temperature of acrylate storage tanks in fire situations, be prepared to provide cooling to the storage tanks, and evacuate personnel if warranted. Incident commanders, fire fighters, and emergency response personnel must be trained on the polymerization hazards of acrylates in order to determine the proper response in an emergency.

### 11.3.1 Procedures

Fire fighters should be equipped with self-contained breathing apparatus (SCBA) and complete personal protective equipment.

An acrylate storage tank fire or a fire in the vicinity of an acrylate storage tank is a very dangerous situation. If the acrylate reaches elevated temperatures, the liquid could polymerize. This could result in a violent reaction, evolving considerable heat and pressure and ejecting hot vapor and polymer. Therefore it is necessary to closely monitor the temperature of the monomer during a fire situation. Quick response is essential for controlling and preventing escalation of the situation.

In the event of a severe fire with or near acrylates, when the liquid temperature reaches 50°C (122°F) it is necessary to evacuate all non-essential personnel to a safe distance from the tank because of the risk of a runaway polymerization. At 60°C (140°F) ALL personnel should be evacuated. Review Section 11.1, “*Detection And Response To Incipient Polymerization In A Storage Tank*” for additional understanding during fire response planning and drills.

In the event of a fire in the immediate vicinity of an acrylate storage container (tank, drum, truck, etc.), apply water spray or fog (deluge system, fire monitor, etc.) to the container’s surface to absorb heat and maintain a lower temperature. This may also help disperse vapors prior to ignition. If an acrylate tank is insulated, caution is necessary when directing a spray onto it so as not to destroy the insulating material. Keep a close watch on the temperature of the storage tank. If the temperature of the acrylate is rising despite the application of cooling water, it may be necessary to add a shortstopping agent, if such a system is available. If the temperature of the acrylate equals or exceeds 50°C (122°F), then a shortstopping agent should be added to limit the risks of the acrylate polymerizing and escalating the situation. Shortstopping agents can be injected using one of the systems outlined in Section 11.1.3.5 of this manual. Please note that shortstopping systems are optional and each facility must evaluate its risks associated with handling and storing acrylates and determine the necessity for a shortstopping system.

If the acrylate tank itself has caught fire, the first step should be to add a shortstop agent as quickly as possible. This will help to prevent a runaway polymerization from occurring, assuming that this was not the cause of the fire.

Consult NFPA 11 for the proper design of fire fighting foam systems. After the fire, continue to monitor the temperature of the storage tank for at least 48 hours to verify that the temperature is dropping to ambient and the tank is stabilized.

### 11.3.2 Extinguishing Media

Use carbon dioxide or dry chemical for small fires and alcohol-resistant (AR-AFFF) foam or water fog for large fires. Acrylate monomers and water are immiscible and therefore water may be ineffective in extinguishing the fire but should be used to keep fire-exposed containers cool. Addition of water to butyl acrylate or 2-ethylhexyl acrylate tanks could result in added venting of steam in the event that the tank temperature reaches 100°C (212°F) from either fire exposure or polymerization. Please note that water and/or foam should not be added into a tank of burning acrylate if the temperature of the liquid in the storage tank has exceeded the boiling point of water, 100°C (212°F). This is because the water could be rapidly vaporized, causing a significant pressure surge and massive venting of a mixture of steam containing acrylate vapor.



### **11.3.3 Fire Prevention Suggestions**

Use non-combustible or fire-resistant area locations for acrylate monomer storage, handling and processing equipment.

- Reduce risk of pool fires around acrylate tanks by using diking design to separate other flammables from acrylate monomers as much as is possible. If possible, separate flammable acrylate monomers from other acrylate monomers.
- Provide adequate venting for emergency conditions in vessels used for storage, handling and processing.
- Use proper electrical equipment and adequate grounding for static electrical discharge.
- Inspect equipment and storage facilities regularly, especially vents and flame arresters.
- Correct any leaks in equipment immediately.
- Provide adequate local exhaust and general ventilation in the working area and perform regular tests with a combustible gas indicator in any area where vapors might accumulate.
- Provide proper facilities to handle any accidental spillage.
- Use non-sparking tools for repair or service operations in any area which might contain combustible vapors.
- Provide adequate fire extinguishing equipment including automatic sprinklers in storage and work areas.
- Do not add dry inhibitor to acrylates by dropping through the vapor space because of the potential for static ignition.

Grateful appreciation is given to the Technical; Manufacturing; and Safety, Health and Environmental Departments of each ICSHAM member company for compiling the information presented in this publication. Further appreciation is given to Basic Acrylic Monomer Manufacturers, Inc. (BAMM) and European Basic Acrylic Monomer Manufacturers (EBAM) for their review of the document.

### 13.1 INCOMPATIBLE MATERIALS

Almost any contamination can potentially destabilize acrylate monomers and should be avoided. The following is a partial list of chemicals which are considered to be incompatible with acrylates. In most cases, these contaminants can cause polymerization of the monomers.

1. peroxide or peroxy- in name
2. per in name, e.g., t-butylperacetate
3. peresters or peroxyesters
4. percarbonates or peroxyarbonates
5. hydroperoxide or hydroperoxy- in name
6. azo compounds
7. azides
8. ethers
9. amines
10. conjugated polyunsaturated acids and esters
11. aldehydes and some ketones
12. reactive inorganic halides (e.g. thionyl chloride, sulfuryl chloride)
13. caustics (e.g., sodium, potassium and calcium hydroxides)
14. strong mineral acids (e.g., nitric, sulfuric, hydrochloric acids)
15. oxidizing agents (e.g., chromic acid, permanganates, nitric acid)
16. varnish
17. inert gases (containing < 5 vol. percent oxygen)
18. carboxylic acid anhydrides
19. mercaptans (thiols)

1. American Industrial Hygiene Association, "Odor Threshold for Chemicals with Established Occupational Health Standards," 1995.
2. J. E. Amore and E. Hautala, "Odor as an Aid to Chemical Safety: Odor Thresholds Compared with Threshold Limit Values and Volatiles for 214 Industrial Chemicals in Air and Water Dilution," *J. Appl. Toxicology*, **3** (6), 272-290 (1983).
3. T. M. Hellman and F. H. Small, "Characterization of the Odor Properties of 101 Petrochemicals Using Sensory Methods," *J. Air Pollution Control Assoc.*, **24** (10), 979-982 (1974).
4. DIPPR values and references cited.
5. Kirk Othmer Encyclopedia of Chemical Technology, "Acrylic Acid and Derivatives," 4th Edition, Release 2001.
6. Ullmann's Encyclopedia of Industrial Chemistry, "Acrylic Acid and Derivatives," 6th Edition, Release 2001.
7. Material Safety Data Sheet, Celanese Ltd., Dallas, Texas.
8. Odor threshold information for 2-Ethylhexyl Acrylate taken from: Basic Acrylic Monomer Manufacturers, Inc., "Basic Acrylic Esters: Background Information."
9. Forsberg and Keith, Chemical Protective Clothing Performance Index, John Wiley & Sons, ISBN 0-471-32844-8.
10. Forsberg and Mansdorf, Quick Selection Guide to Chemical Protective Clothing, John Wiley & Sons, ISBN 0-471-28797-0.
11. Basic Acrylic Monomer Manufacturers, Inc., "Chemical-Protective Gloves for Acrylic Acid and Acrylic Esters," Brochure, 1999.
12. L. B. Levy, *J. Poly. Sci. Pt. A*, **30**, 569-576 (1992).
13. Anon., *I Chem E (U.K.), Loss Prevention Bulletin*, Issue 126, 3-6 (1995); *ibid.*, Issue 128, 27 (1996).
14. L. B. Levy, *J. Poly. Sci., Poly. Chem. Ed.*, **23**, 1505-1515 (1985).
15. L. B. Levy, *Plant/Operations Progress*, **6**, 188-189 (1987).
16. J. J. Kurland, *J. Polym. Sci. Polym. Chem. Ed.*, **18**, 1139-1145 (1980).
17. L. B. Levy and M. B. Lakin, *Process Safety Progress*, **12**, 111-114 (1993).
18. C.A. Staples, S.R. Murphy, J.E. McLaughlin, H.-W. Leung, T.C. Cascieri, C.H. Farr, "Determination of selected fate and aquatic toxicity characteristics of acrylic acid and a series of acrylic esters", *Chemosphere*, **40**, 29-38 (2000).
19. L. B. Levy and J. D. Penrod, *Plant/Operations Progress*, **8**, 105-108 (1989).
20. P. D. Hoffman, *AIChE Symposium Series No. 286*, **88**, 77-82 (1992).
21. BASF Acrylic Monomers, "Emergency Restabilization with RESTAB Technology."

**BASF CORPORATION**

Chemicals Division  
Acrylic Monomers  
3000 Continental Drive North  
Mount Olive, New Jersey, 07828-1234  
USA  
(973)426-2600

**CELANESE, LIMITED**

1601 West LBJ Freeway  
Dallas, Texas 75234  
(214)277-4000

**ATOFINA Chemicals, Inc.**

2000 Market Street  
Philadelphia, Pennsylvania 19103  
(215)419-7000

**ROHM AND HAAS COMPANY**

100 Independence Mall West  
Philadelphia, Pennsylvania 19106-2399  
(215)592-3000

**The Dow Chemical Company**

2040 Dow Center  
Midland, Michigan 48674  
(800)441-4369